



E-BIKES

TRANSLATION OF THE ORIGINAL  
OPERATING INSTRUCTIONS

EN

Lacuba Evo 8, Lacuba Evo 25, Lacuba Evo 25S,  
Lacuba Evo Cross, Lacuba Evo Lite 11, Lacuba Evo Lite 5

19-17-1009, 19-17-1010, 19-17-1011, 19-17-1012, 19-17-1013, 19-17-1014, 19-17-1015, 19-17-1016,  
19-17-1017, 19-17-1018, 19-17-1019, 19-17-4133, 19-17-4134, 19-17-4135, 19-17-4136, 19-17-4137,  
19-17-4138, 19-17-4138

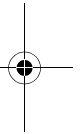
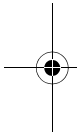
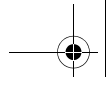

## Copyright

© ZEG Zweirad-Einkaufs-Genossenschaft eG

Distribution or reproduction of these operating instructions and utilisation or communication of their content is prohibited unless expressly approved. Any infringement will render the offender liable for compensation. All rights reserved in the event that a patent, utility model or industrial design is registered.

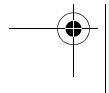
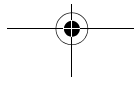

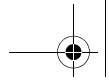

## Data sheet

Surname, first name of the purchaser:

---

Date of purchase:

---

Model:

---

Frame number:

---

Type number:

---

Unladen weight (kg):

---

Tyre size:

---

Recommended tyre pressure (bar)\*: front:                      rear:

---

Wheel circumference (mm):

---

Company stamp and signature:

\*After a tyre change, refer to the tyre markings for the permitted tyre pressures and make sure that they are observed. The recommended tyre pressure must not be exceeded.

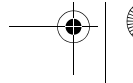
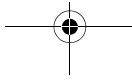

## Table of contents

# Table of contents

<b>1</b>	<b>About these instructions</b>	<b>8</b>
1.1	Manufacturer	8
1.2	Laws, standards and directives	9
1.3	Other valid documents	9
1.4	Subject to change	10
1.5	Language	10
1.6	For your safety	11
1.6.1	Instruction, training and customer service	11
1.6.2	Basic safety notes	12
1.6.3	Warnings	12
1.6.4	Safety markings	13
1.7	For your information	13
1.7.1	Instructions for actions	13
1.7.2	Information on the type plate	13
1.7.3	Language conventions	15
1.8	Type plate	17
1.9	Identifying	18
1.9.1	Operating instructions	18
1.9.2	Bicycle	18
<b>2</b>	<b>Safety</b>	<b>19</b>
2.1	Requirements for the rider	19
2.2	Hazards for vulnerable groups	19
2.3	Personal protective equipment	19
2.4	Proper use	20
2.4.1	City and trekking bicycle	20
2.5	Improper use	21
2.5.1	City and trekking bicycle	21
2.6	Duty to take care	22
2.6.1	Rider	22
2.6.2	Operator	22
<b>3</b>	<b>Description</b>	<b>24</b>
3.1	Overview	24
3.2	Handlebars	25
3.3	Wheel and fork	26
3.3.1	Valve	26

---

**Table of contents**

3.4	Brake system	28
3.4.1	Rim brake	28
3.4.2	Disc brake	30
3.4.3	Back-pedal brake	31
3.4.4	Suspension	32
3.4.5	Suspension fork structure	33
3.4.5.1	Air suspension fork structure	34
3.5	Electric drive system	35
3.6	Drive system	35
3.6.1	Rechargeable battery	37
3.6.1.1	Charge status indicator	38
3.6.1.2	Range	39
3.6.2	Driving light	39
3.6.3	USB port	39
3.6.4	Display	40
3.6.4.1	Indicators	41
3.6.5	Operating element	45
<b>4</b>	<b>Technical data</b>	<b>46</b>
<b>5</b>	<b>Transportation, storage and assembly</b>	<b>49</b>
5.1	Transportation	49
5.1.1	Transporting the battery	51
5.1.2	Using the transport securing system	51
5.2	Storing	52
5.2.1	Break in operation	53
5.2.1.1	Preparing a break in operation	53
5.2.1.2	Taking out of operation	53
5.3	Brake system	54
5.4	Assembly	55
5.4.1	Required tools	55
5.4.2	Unpacking	56
5.4.3	Scope of delivery	56
5.4.4	Commissioning	57
5.4.4.1	Checking the battery	59
5.4.5	Mounting the wheel in the Suntour fork	60
5.4.5.1	Mounting the wheel with screw-on axle (15 mm)	60
5.4.5.2	Mounting the wheel with screw-on axle (20 mm)	62
5.4.5.3	Mounting the wheel with a quick release axle	63

## Table of contents

---

5.4.6	Mounting the wheel with a quick release	67
5.4.6.1	Checking the stem and handlebars	70
5.4.7	Sale of the bicycle	71
<b>6</b>	<b>Before the first ride</b>	<b>72</b>
6.1	Adjusting the saddle	72
6.1.1	Adjusting the saddle tilt	72
6.1.2	Determining the seat height	73
6.1.3	Adjusting the seat height with quick release	74
6.1.4	Setting the height-adjustable seat post	76
6.1.4.1	Lowering the saddle	76
6.1.4.2	Raising the saddle	76
6.1.5	Adjusting the seat position	77
6.2	Adjusting the handlebars	78
6.2.1	Adjusting the height of the handlebars	79
6.2.2	Turning the handlebars to the side	80
6.2.2.1	Checking the clamping force of the quick releases	81
6.2.2.2	Adjusting the quick release clamping force	81
6.3	Adjusting the brake lever	81
6.3.1	Adjusting the pressure point on a Magura brake lever	81
6.3.2	Adjusting the grip distance	82
6.3.2.1	Adjusting the grip distance on a Magura brake lever	83
6.4	Adjusting the suspension	84
6.4.1	Adjusting the negative deflection	85
6.4.1.1	Adjusting the steel suspension fork negative deflection	85
6.4.1.2	Adjusting the air suspension fork negative deflection	86
6.5	Retracting brake linings	87
<b>7</b>	<b>Operation</b>	<b>88</b>
7.1	Before each ride	90
7.2	Check list before each ride	91
7.3	Using the kickstand	92
7.4	Using the pannier rack	93
7.5	Rechargeable battery	95
7.5.1	Removing the battery	97
7.5.2	Inserting the battery	97
7.5.3	Charging the battery	98
7.5.4	Waking the battery	99
7.6	Electric drive system	100

---

 Table of contents
 

---

7.6.1	Switching on the drive system	100
7.6.2	Activating the standby mode	100
7.6.3	Switching off the drive system	101
7.7	Control panel with display	102
7.7.1	Removing and attaching the display	102
7.7.2	Using the driving light	103
7.7.3	Using the push assist system	104
7.7.4	Selecting the level of assistance	105
7.7.5	Switching journey information	105
7.7.6	Using the USB port	105
7.7.7	Changing the system information	106
7.8	Gear shift	107
7.8.1	Selecting gears	107
7.8.2	Using the derailleur gears	108
7.8.3	Using a hub gear	109
7.9	Brake	111
7.9.1	Using the brake lever	115
7.9.2	Using the back-pedal brake	115
7.10	Suspension and damping	116
7.10.1	Adjusting the compression of the Suntour fork	116
7.10.2	Adjusting the compression of the Fox fork	117
7.10.3	Adjusting the compression of the Fox fork	118
<b>8</b>	<b>Maintenance</b>	<b>120</b>
8.1	Cleaning and servicing	122
8.1.1	After each ride	122
8.1.1.1	Cleaning the suspension fork	122
8.1.1.2	Cleaning the rear frame damper	122
8.1.1.3	Cleaning the pedals	122
8.1.2	Basic cleaning	123
8.1.2.1	Cleaning the frame	124
8.1.2.2	Cleaning the stem	124
8.1.2.3	Cleaning the rear frame damper	124
8.1.2.4	Cleaning the wheel	124
8.1.2.5	Cleaning the drive elements	125
8.1.2.6	Cleaning the chain	125
8.1.2.7	Cleaning battery	126
8.1.2.8	Cleaning the display	126
8.1.2.9	Cleaning the drive unit	127

## Table of contents

---

8.1.2.10	Cleaning the brake	127
8.1.3	Servicing	128
8.1.3.1	Servicing the frame	128
8.1.3.2	Servicing the stem	128
8.1.3.3	Servicing the fork	128
8.1.3.4	Servicing the drive elements	128
8.1.3.5	Servicing the pedal	128
8.1.3.6	Servicing the chain	129
8.1.3.7	Servicing the drive elements	129
8.2	Maintenance	130
8.2.1	Wheel	130
8.2.2	Brake system	131
8.2.3	Electrical cables and brake cables	131
8.2.4	Gear shift	131
8.2.5	Stem	132
8.2.6	Checking the chain and belt tension	132
8.2.7	USB port	133
8.2.8	Suspension fork	133
8.3	Service	134
8.4	Adjusting and repairing	136
8.4.1	Use original parts and lubricants only	136
8.4.2	Wheel quick release	137
8.4.2.1	Clamping the clamping lever	138
8.4.2.2	Clamping version I	138
8.4.2.3	Clamping version II	139
8.4.2.4	Clamping version III	140
8.4.2.5	Clamping version IV	141
8.4.2.6	Clamping version V	142
8.4.3	Adjusting the tyre pressure	144
8.4.3.1	Dunlop valve	144
8.4.3.2	Presta valve	145
8.4.3.3	Schrader valve	146
8.4.4	Adjusting the gear shift	147
8.4.5	Cable-operated gear shift, single-cable	147
8.4.6	Cable-operated gear shift, dual-cable	148
8.4.7	Cable-operated twist grip, dual-cable	149
8.4.8	Offsetting the brake lining wear	150
8.4.9	Hydraulically operated rim brake	150



---

**Table of contents**

8.4.10	Hydraulically operated disc brake	151
8.4.11	Replacing the lighting	151
8.4.12	Setting the headlight	151
8.4.13	Repair by the specialist dealer	151
8.4.14	Replacing the lighting	152
8.4.15	Setting the headlight	152
8.4.16	Repair by the specialist dealer	152
8.4.17	First aid for system messages	153
8.4.17.1	First aid	153
8.4.18	First aid in case of complete failure	154
8.5	Accessories	155
8.5.1	Child seat	155
8.5.2	Bicycle trailer	157
8.5.3	Pannier rack	158
<b>9</b>	<b>Recycling and disposal</b>	<b>159</b>
<b>10</b>	<b>Appendix</b>	<b>161</b>
10.1	System messages	161
10.2	EC declaration of conformity	163
10.3	Parts list	164
10.4	Table of figures	168
10.5	Index	171

## About these instructions

# 1

## About these instructions

Read these operating instructions before commissioning the bicycle to ensure you use all the functions correctly and safely. The operating instructions are not a substitute for personal instruction by the supplying specialist dealer. The operating instructions are a component part of the bicycle. Therefore, if it is re-sold at a later time, they must be handed over to the subsequent owner.

These operating instructions are mainly intended for the rider and operator of the bicycle, who tend to be non-professionals.



Text passages which are expressly intended for specialist staff (e.g. bicycle mechanics) are clearly marked with a tool symbol.

Staff at all specialist dealers have specialist training and qualifications, and are therefore capable of identifying risks and preventing hazards which may arise during maintenance, servicing and repairs on the bicycle. Information for specialist staff does not require non-professionals to take any action.

### 1.1

#### Manufacturer

The manufacturer of the bicycle is:

ZEG Zweirad-Einkaufs-Genossenschaft eG  
Longericher Straße 2  
50739 Köln, Germany

Tel.: +49 221 17959 0  
Fax: +49 221 17959 31  
E-mail: [info@zeg.de](mailto:info@zeg.de)  
Internet: [www.zeg.de](http://www.zeg.de)

## 1.2 Laws, standards and directives

These operating instructions comply with the essential requirements from:

- Machinery Directive 2006/42/EC,
- Electromagnetic Compatibility Directive 2014/30/EU,
- EN ISO 12100:2010 Safety of machinery – General principles of design – Risk assessment and reduction,
- EN 15194:2015, Cycles – Electrically power assisted cycles – EPAC bicycles,
- EN ISO 4210, Cycles – Safety requirements for bicycles,
- EN 11243:2016, Cycles – Luggage carriers for bicycles – Requirements and test methods,
- EN 82079-1:2012, Preparation of instructions for use – Structuring, content and presentation – Part 1: General principles and detailed requirements and
- EN ISO 17100:2016-05, Translation Services – Requirements for translation service.

## 1.3 Other valid documents

These operating instructions are only complete in conjunction with the other valid documents.

The following document applies for this product:

- Charger operating instructions.

No other information is also applicable.

The constantly updated lists of approved accessories and parts are available to specialist dealers.

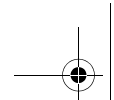

## About these instructions

---



### **1.4 Subject to change**

The information contained in these operating instructions are the approved technical specifications at the time of printing. Any significant changes are included in a new issue of the operating instructions.

You will find any modifications to these operating instructions at:  
[www.bulls.de/service/downloads](http://www.bulls.de/service/downloads)

### **1.5 Language**

The original operating instructions are written in German. A translation is not valid without the original operating instructions.

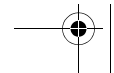
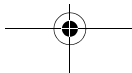
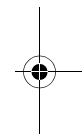
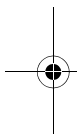

## 1.6

### For your safety

The safety concept of the bicycle comprises four elements:

- rider and/or operator instruction, and bicycle maintenance and repair by the specialist dealer,
- the chapter on general safety,
- the warnings in these instructions and
- the safety marking on the type plates.

### 1.6.1

#### Instruction, training and customer service

The supplying specialist dealer will provide customer service. Contact details can be found on the back page of these operating instructions and in the data sheet. If you are unable to contact your specialist dealer, you will find other specialist dealers at [www.zeg.de](http://www.zeg.de).



The specialist dealer authorised to perform repairs and maintenance work receives regular training.

The rider or the operator of the bicycle will be instructed in person on the bicycle functions when the supplying specialist dealer hands over the bicycle, if not before. This instruction particularly covers the bicycle's electrical functions and correct use of the charger.

Each rider to whom this bicycle is provided must receive instruction on the bicycle's functions. The operating instructions must be submitted to each rider in printed form and must be acknowledged and adhered to.

## About these instructions





---

### 1.6.2 Basic safety notes

These operating instructions have a chapter with general safety notes [▷ *Chapter 2, page 19*]. You can distinguish this chapter as it has a grey background.

### 1.6.3 Warnings

Hazardous situations and actions are marked with warnings. The warnings in these operating instructions are shown as follows:

SIGNAL WORD	Type and source of the danger
	Description of the danger and the consequences.
	▶ Measures
	The following pictograms and signal words are used in the operating instructions for warnings and information notices:
	Will lead to serious or even fatal injuries if ignored. High-risk hazard.
	May lead to serious or even fatal injuries if ignored. Medium-risk hazard.
	May lead to minor or moderate injuries. Low-risk hazard.
	May lead to material damage if ignored.

**Table 1:** Meanings of the signal words

## 1.6.4 Safety markings

The following safety markings are used on the bicycle's type plates:



General warning



Adhere to the instructions for use

Table 2:

### Safety markings on the product

## 1.7 For your information

### 1.7.1 Instructions for actions

Instructions for actions are structured in accordance with the following pattern:

- ✓ Requirements (optional)
- ▶ Instruction for action
- ⇒ Result of the action (optional)

### 1.7.2 Information on the type plate

Alongside the warnings, the type plates of the products also contain other important information on the bicycle:

## About these instructions

---





	<b>1</b>	only suitable for the road, no off-road riding or jumps
	<b>2</b>	suitable for roads, off-road riding and jumps of up to 15 cm
	<b>3</b>	suitable for rough off-road riding and jumps of up to 61 cm
	<b>4</b>	suitable for rough off-road riding and jumps of up to 122 cm
	<b>5</b>	suitable for the most difficult terrain

Table 3:

### Area of use







	City and trekking bicycle
	Child's bicycle / bicycle for young adults
	BMX bicycle
	Mountain bike
	Racing bicycle
	Carrier bicycle
	Folding bicycle

Table 4:

### Bicycle type

---



About these instructions











		Read the instructions
		Separate collection of electrical and electronic devices
		Separate collection of ordinary and rechargeable batteries
		Must not be thrown into fire (burning prohibited)
		Must not be thrown into water (immersed)
		Device of protection class II
		Only suitable for use indoors
		Fuse (device fuse)
		EU conformity
		Recyclable material

Table 5:

Information on the type plate

1.7.3

**Language conventions**

The bicycle described in these operating instructions may be equipped with alternative components. The equipment of the bicycle is defined by the respective type number. If applicable, the notes *alternative equipment* and *alternative version* make reference to the use of alternative components.

## About these instructions

---

*Alternative equipment* describes additional components which are not necessarily an integral part of every bicycle in these instructions.

*Alternative version* explains the various variants of components if they differ in use.

The following terms are used for better legibility:

Term	Meaning
Operating instructions	Original operating instructions or translation of the original operating instructions
Bicycle	Electric motor driven cycle
Motor	Drive motor

The following conventions are used in these operating instructions:

Convention	Use
<i>Italics</i>	Entry in the index
SPACED	Indicators on the <i>display screen</i>
[▷ <i>Example, page numbering</i> ]	Cross references
•	Bulleted lists

## 1.8 Type plate

The type plate is situated on the *frame*. The type plate features the following information:

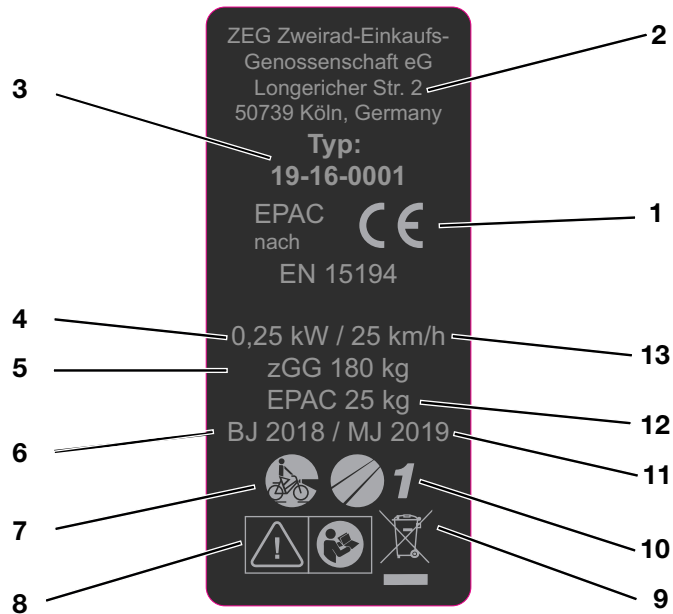

Figure 1:

### Type plate, example

- 1 CE marking
- 2 Manufacturer
- 3 Type number
- 4 Nominal continuous power
- 5 Permitted total weight
- 6 Year of manufacture
- 7 *Bicycle type*
- 8 *Safety instructions*
- 9 *Disposal instruction*
- 10 *Area of use*
- 11 Model year
- 12 Weight of the ready-to-ride bicycle
- 13 Shut-off speed

## About these instructions

### 1.9 Identifying

#### 1.9.1 Operating instructions

The identification number of these operating instructions is made up of the document number, the version number and the release date. It can be found on the cover page and in the footer.

<b>Identification number</b>	034-03212_1.0_03.12.2018
------------------------------	--------------------------

**Table 6: Identification number of the operating instructions**

#### 1.9.2 Bicycle

These BULLS operating instructions refer to the *model year* 2019. The production period is from August 2018 to July 2019. They are issued in August 2018.

The operating instructions are a component part of the following bicycles:

<b>Type number</b>	<b>Model</b>	<b>Bicycle type</b>
19-17-1009	Lacuba Evo 8	City and trekking bicycle
19-17-1010	Lacuba Evo 8	City and trekking bicycle
19-17-1011	Lacuba Evo 8	City and trekking bicycle
19-17-1012	Lacuba Evo 25	City and trekking bicycle
19-17-1013	Lacuba Evo 25	City and trekking bicycle
19-17-1014	Lacuba Evo 25	City and trekking bicycle
19-17-1015	Lacuba Evo 25S	City and trekking bicycle
19-17-1016	Lacuba Evo 25S	City and trekking bicycle
19-17-1017	Lacuba Evo 25S	City and trekking bicycle
19-17-1018	Lacuba Evo Cross	City and trekking bicycle
19-17-1019	Lacuba Evo Cross	City and trekking bicycle
19-17-4133	Lacuba Evo Lite 11	City and trekking bicycle
19-17-4134	Lacuba Evo Lite 11	City and trekking bicycle
19-17-4135	Lacuba Evo Lite 11	City and trekking bicycle
19-17-4136	Lacuba Evo Lite 11	City and trekking bicycle
19-17-4137	Lacuba Evo Lite 5	City and trekking bicycle
19-17-4138	Lacuba Evo Lite 5	City and trekking bicycle
19-17-4138	Lacuba Evo Lite 11	City and trekking bicycle

**Table 7: Bicycle definition by type number, model and bicycle type**

## 2

## Safety

### 2.1

### Requirements for the rider

If there are no legal requirements for riders of electrically power-assisted cycles, we recommend that the rider should be a minimum 14 years of age and have experience with muscle-powered bicycles.

The rider's physical and mental abilities must be adequate to use a muscle-powered bicycle.

### 2.2

### Hazards for vulnerable groups

The battery and charger must be kept out of the reach of children.

If the bicycle is used by minors, comprehensive instruction should be provided by or in the presence of the legal guardians. Supervised use should also be scheduled until it is certain that the bicycle is being used as per these operating instructions. Legal guardians hold sole responsibility for determining whether minors are capable of using the bicycle.

### 2.3

### Personal protective equipment

We recommend that you wear a suitable safety helmet. We also recommend that you wear typical, long, close-fitting cycling clothing and sturdy footwear.

## Safety

### 2.4

#### Proper use

The bicycle is designed to support a maximum speed of 25 km/h. The bicycle may only be used in a perfect, fully functional condition.

National requirements may apply to the bicycle which differ from the standard equipment. For riding on public roads, some special regulations apply in relation to the *driving light*, *reflectors* and other components.

The general laws and the regulations for the prevention of accidents and environmental protection in the respective country of use must be adhered to. All check lists and instructions for actions in these operating instructions must be met. Approved accessories can be installed by specialist staff.

Each bicycle is assigned a *bicycle type*, which determines its proper use and area of use.

#### 2.4.1



#### City and trekking bicycle

City and trekking bicycles are designed for daily, comfortable use. They are suitable for riding on public roads.

#### Area of use:



**1**

Suitable for tarmacked and paved roads.



**2**

Suitable for tarmacked roads, cycle paths and firm gravel paths and roads, and longer sections with moderate slopes and jumps up to 15 cm.

## 2.5

### Improper use

Failure to adhere to the proper use poses a risk of personal injury and material damage. The bicycle is not suitable for the following uses:

- when the electrical drive system has been manipulated
- when the permitted gross load weight is exceeded
- riding with a damaged or incomplete bicycle
- riding over steps
- riding through deep water
- lending the bicycle to untrained riders
- carrying other people
- riding with excessive or unsecured luggage
- riding with no hands
- riding on ice and snow
- improper servicing
- improper repair
- tough areas of use, such as professional competitions
- stunt riding or acrobatics.

### 2.5.1



#### City and trekking bicycle

City and trekking bicycles are not sports bicycles. If used for sports, the rider can expect reduced riding stability and diminished comfort.

#### Non-permitted areas of use:



**1**

Never drive off-road or perform jumps.



**2**

Never drive off-road or perform jumps over 15 cm.

## Safety

---

### 2.6

#### Duty to take care

The safety of the bicycle can only be assured if all the necessary measures are taken.

#### 2.6.1

##### Rider

The rider:

- receives instruction before the first ride. They can clarify any questions relating to the operating instructions with the operator or specialist dealer
- wears personal protective equipment.
- assumes all the obligations of the operator in case the bicycle changes hands.

#### 2.6.2

##### Operator

The operator has the duty of care and responsibility for scheduling these measures and checking that they are implemented.

The operator:

- makes these operating instructions available to the rider for the duration of use of the bicycle. If necessary, they translate the operating instructions into a language which the rider understands.
- familiarises the rider with the functions of the bicycle before the first ride. Only riders who have received instruction may be allowed to ride.
- instructs the rider on proper use and the wearing of personal protective equipment.
- only employs specialist staff for maintenance and repair of the bicycle
- ensures that there is no unauthorised access, such as preventing replacement of gear sprockets with parts which are not original parts.

The printed EC Declaration of Conformity in the appendix is valid providing that the bicycle remains unchanged from its original condition. As soon as the operator makes any relevant modifications or



## Safety

additions, they legally become the manufacturer. He must independently guarantee compliance with the EC directives again in order to:

- circulate the bicycle again,
- attach the CE marking again and
- avoid compromising occupational safety.

Description

### 3 Description

#### 3.1 Overview



**Figure 2:** Bicycle viewed from the right; Lacube EVO Lite 5 used as example

- 1 *Front wheel*
- 2 *Fork*
- 3 *Front mudguard*
- 4 *Headlight*
- 5 *Handlebars*
- 6 *Stem*
- 7 *Frame*
- 8 *Seat post*
- 9 *Saddle*
- 10 *Pannier rack*
- 11 *Reflector and rear light*
- 12 *Rear mudguard*
- 13 *Rear wheel*
- 14 *Kickstand*
- 15 *Chain*
- 16 *Chain guard*
- 17 *Rechargeable battery, frame number and type plate*

### 3.2 Handlebars



**Figure 3:** Detailed view of bicycle from rider position, example

- 1 Rear brake lever
- 2 Bell
- 3 Headlight
- 4 Front brake lever
- 5 Gear shift
- 6 Operating element
- 7 Display
- 8 Fork lock
- 9 Gear shift

## Description

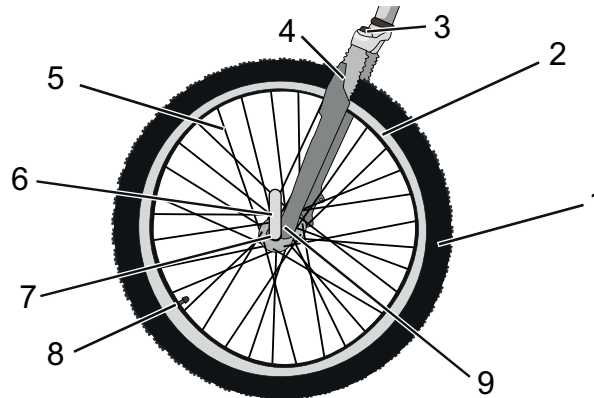
**3.3 Wheel and fork**

**Figure 4:** Components of the wheel – example showing front wheel

- |   |   |
|---|---|
| 1 | Tyre                                    |
| 2 | Rim                                     |
| 3 | Suspension fork head with setting wheel |
| 4 | Fork                                    |
| 5 | Spoke                                   |
| 6 | Quick release                           |
| 7 | Hub                                     |
| 8 | Valve                                   |
| 9 | Fork end of the suspension fork         |

**3.3.1 Valve**

Each wheel has a valve. It is used to fill the *tyre* with air. There is a valve cap on each valve. The screw-on valve cap keeps out dust and dirt.

The bicycle either has a classical *Dunlop valve*, a *Presta valve* or a *Schrader valve*.

### Dunlop valve



The rider can easily exchange the valve and quickly release the air. The air pressure cannot be measured with this valve.

### Presta valve



The Presta valve requires a smaller hole in the rim, which is why it is especially suitable for the narrow rims of racing bicycles. The air pressure can be measured with this valve.

### Schrader valve



The rider can fill the Schrader valve very easily at a petrol station. The air pressure can be measured with this valve.

## Description

### 3.4 Brake system

The bicycle's brake system comprises either a hydraulic:

- rim brake on the front and rear wheels,
- disc brake on the front and rear wheels or
- a rim brake on the front and rear wheels and an additional back-pedal brake.

#### 3.4.1 Rim brake *Alternative*

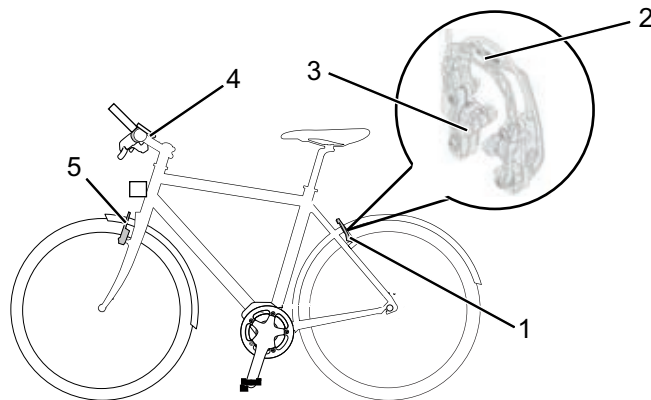

Figure 5: Rim brake components with details; Magura HS22 used as an example

- 1 Rear wheel rim brake
- 2 Brake booster
- 3 Brake lining
- 4 *Handlebars with brake levers*
- 5 Front wheel rim brake

The rim brake stops the wheel moving when the rider pulls the *brake lever*, causing two brake linings, positioned opposite one another, to be pressed onto the *rims*.

Description

The hydraulic rim brake features a locking lever

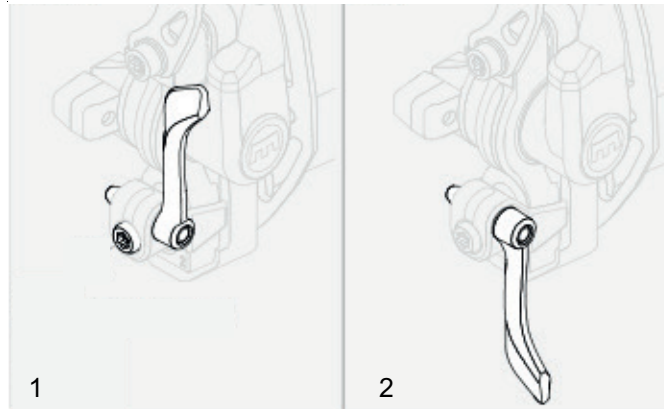

Figure 6:

*Rim brake locking lever, closed (1) and open (2)*



The rim brake locking lever is not marked with any lettering. Only a specialist dealer may set the rim brake locking lever.

## Description

### 3.4.2 Disc brake *Alternative*

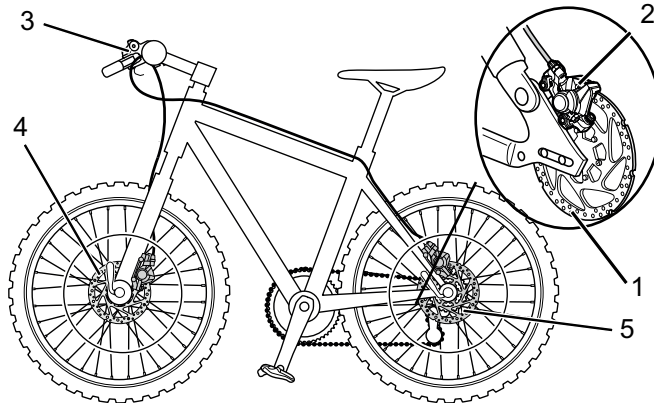

**Figure 7:** Bicycle brake system with a disc brake, example

- 1 Brake disc
- 2 Brake calliper with brake linings
- 3 *Handlebars with brake levers*
- 4 Front wheel brake disc
- 5 Rear wheel brake disc

On a bicycle with a disc brake, the brake disc is screwed permanently to the *hub* of the wheel.

The brake lever is pulled to increase brake pressure. The brake fluid is used to transfer pressure through the brake lines to the cylinders in the brake calliper. The braking force is boosted by a speed reduction and applied to the brake linings. These apply the brake disc mechanically. If the brake lever is pulled, the brake linings are pressed against the brake disc, and the movement of the wheel is decelerated until it comes to a stop.



### 3.4.3 Back-pedal brake *Alternative*

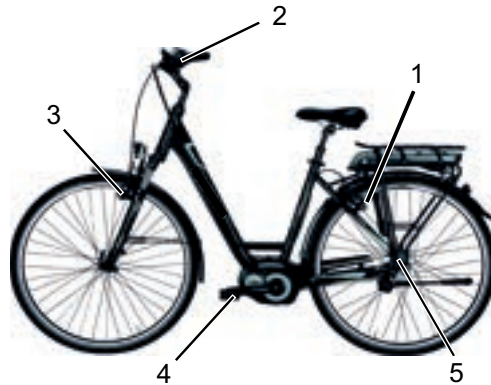

**Figure 8:** Brake system with a back-pedal brake, example

- 1 Rear wheel rim brake
- 2 *Handlebars with brake levers*
- 3 Front wheel rim brake
- 4 *Pedal*
- 5 Back-pedal brake

The back-pedal brake stops the movement of the rear wheel when the rider pedals in the opposite direction to the direction of travel.

## Description

### 3.4.4 Suspension

Both forks and suspension forks are fitted in this model series. A suspension fork is based either on a steel spring or air suspension. Unlike a rigid fork, a suspension fork has two functions which improve floor contact and comfort: suspension and damping.

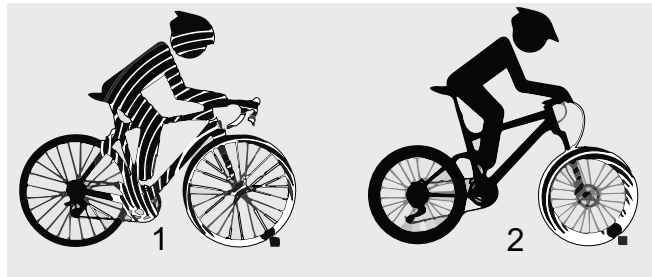

**Figure 9:** Bicycle without suspension (1) and with suspension (2) when riding over an obstacle

The suspension prevents an impact, such as one caused by a stone lying in the bike's path, from being channelled directly into the rider's body via the fork. The impact is absorbed by the suspension system instead. This causes the suspension fork to compress. The compression can be disabled so that a suspension fork reacts like a rigid fork. The switch to disable the fork is called a remote lockout.

After compressing, the suspension fork returns to its original position. If there is a damper, it decelerates movement, preventing the suspension system from springing back in an uncontrolled manner and stopping the fork from vibrating up and down.

## Description

Dampers which dampen compressive deflection movements, i.e. a compression load, are called compression dampers or compression dashpots.

Dampers which dampen rebound deflection movements, i.e. a rebound load, are called rebound dampers or dashpots.

### 3.4.5 Suspension fork structure

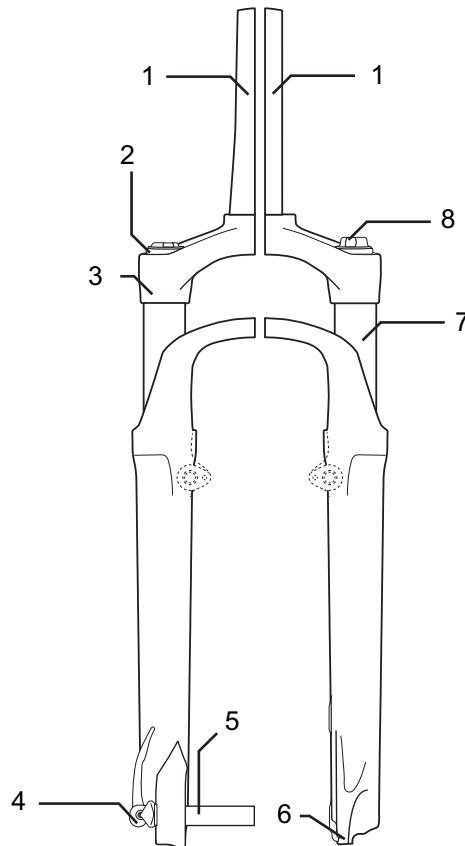

Figure 10:

Example showing Suntour fork: The stem and handlebars are fastened to the fork shaft (1). The wheel is fastened to the quick release axle (6). Other elements: The compression setting (2), crown (3), Q-Loc (5), dust seal (6), fork end for quick release (7), stanchion (8) and spring (9)

## Description

### 3.4.5.1 Air suspension fork structure

The fork of the bicycle features both air suspension and a compression damper, in addition to a rebound damper in some cases.



**Figure 11:** Air suspension fork structure, Suntour

Diagram with the operating elements: Air valve (1), valve cap (2) fork lock (3), quick release (4) and rebound damper adjuster (5) and the assembly groups: Air suspension fork (A), compression damper assembly group (B) and rebound damper assembly group (C)

### 3.5 Electric drive system

### 3.6 Drive system

The bicycle is driven by muscle power via the chain drive. The force which is applied by pedalling in the direction of travel, drives the front chain wheel. The chain transmits the force onto the rear chain wheel and then onto the rear wheel.

You can ride the bicycle like a normal bike at any time, either by switching off the electric drive system or changing the level of assistance to Off. The same applies when the battery is empty.

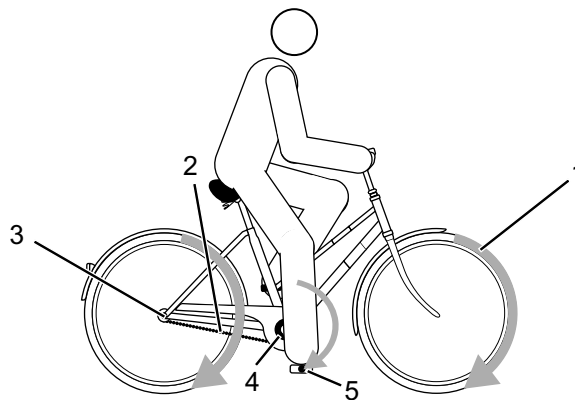

Figure 12:

Diagram of drive system

- 1 Direction of travel
- 2 Chain
- 3 Rear chain wheel
- 4 Front chain wheel
- 5 Pedal

## Description

As well as a drive system operated by muscle power, the bicycle also has an integrated, electric drive system. The electric drive system is made up of 8 components:

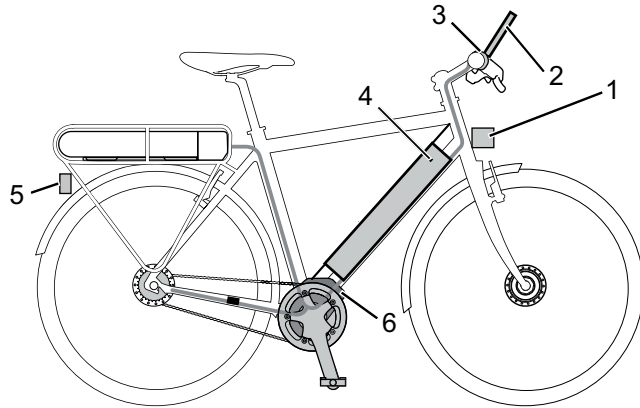

Figure 13:

### Diagram of electric drive system

- 1 *Headlight*
  - 2 *Display*
  - 3 *Operating element*
  - 4 Rechargeable battery
  - 5 Rear light
  - 6 Motor
- A charger which is designed for the battery.

As soon as the required muscle power from the rider pedalling passes a certain level, the motor is activated gently and assists the pedalling motion of the rider. The motor force is determined by the set level of assistance. The assistance depends on the force applied to the pedals by the rider. Drive system assistance is therefore only activated when the rider pedals. This happens regardless of the selected level of assistance. The motor switches off automatically as soon as the rider no longer pedals, the temperature is outside the permitted range, there is an overload or the shut-off speed of 25 km/h has been reached.

## Description

If the speed falls below 25 km/h, the assistance is automatically activated again.

A push assist system can be activated. The push assist continues to drive the bicycle as long as the rider pushes the plus button on the *handlebars*. The speed can be a maximum of 6 km/h in this case.

## 3.6.1

**Rechargeable battery**

The lithium ion battery has an internal electronic protection circuit. It is matched to the charger and the bicycle. The battery temperature is monitored at all times. The battery is protected against deep discharge, overcharging, overheating and short circuit. In the event of a hazard, a protective circuit switches the battery off automatically. The battery also switches to sleep mode for self-protection when not used for a longer period. The battery's service life can be extended if it is well maintained and, above all, stored at the correct temperatures. The battery charge status will decrease with age, even if the battery is maintained properly. If the operating time is severely shortened after charging, this is a sign that battery has reached the end of its useful life.

<b>Transportation temperature</b>	5 °C–25 °C
<b>Ideal transportation temperature</b>	10 °C–15 °C
<b>Storage temperature</b>	5 °C–25 °C
<b>Ideal storage temperature</b>	10 °C–15 °C
<b>Charging ambient temperature</b>	10 °C–30 °C

Table 8:

**Rechargeable battery technical data**

## Description

The bicycle has two types of battery: either an Evo 650 battery or a SuperCore battery

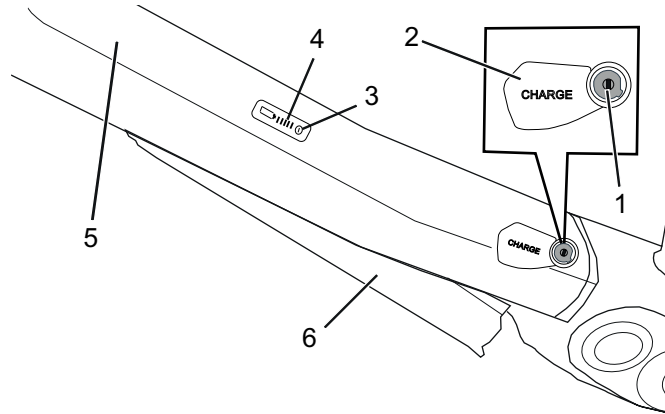

**Figure 14:** Evo 650 battery details with battery lock (1), port for charger plug (2), On-Off button (3), operating and charge status indicator (4), top of down tube (5) and swung-out battery (6)

### 3.6.1.1

#### Charge status indicator

The five green LEDs on the charge status indicator show the battery charge status when the battery is switched on. Each LED represents 20% of the charge status. The charge status of the switched-on battery is also shown on the *display*.

If the battery charge status falls below 5%, all the LEDs on the operating and charge status indicator will go out. However, the charge status is still shown on the *display*.



**3.6.1.2****Range**

The range is influenced by many factors, such as:

- Level of assistance: The higher the selected level of assistance, the lower the range.
- gear switching habits,
- tyre type,
- tyre pressure,
- the age, condition and charge status of the battery,
- route profile (slopes) and route quality (road surface),
- weather conditions (e.g. opposing winds, ambient temperature, etc.),
- e-bike weight and
- load.

**3.6.2****Driving light**

When the driving light is activated, the *headlight* and the rear light are switched on.

**3.6.3****USB port**

The display has a micro USB port on the underside. With a suitable USB cable, you can charge devices such as your mobile. The charging current is 0.5 amps. Please observe the permissible charging currents of your devices.

<b>Charge voltage</b>	5 V
<b>Charging current</b>	max. 500 mA

**Table 9:****USB port technical data**

Description

3.6.4

Display

The display shows all ride data. The bicycle's battery supplies the display with energy when the display is inserted in the mount, a sufficiently charged battery is inserted into the bicycle, and the drive system is switched on.

Internal lithium ion battery	3.7 V, 240 mAh
Storage temperature	5 °C–25 °C
Charging ambient temperature	10 °C–30 °C

Table 10:

Display technical data  
The *display* has a USB port.



Figure 15:

Display details

Use	
1	Screen display
2	USB port

Table 11:

Display overview

### 3.6.4.1

### Indicators

The *display* has ten on-screen indicators:

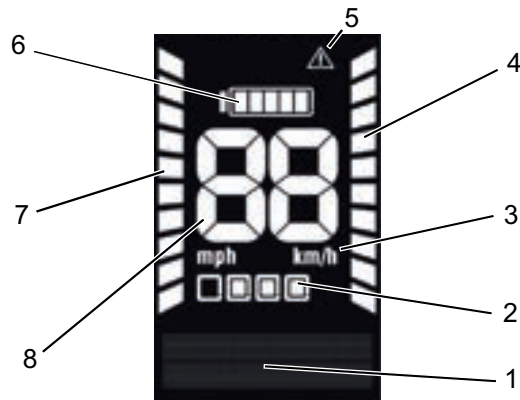

Figure 16:

On-screen indicators overview

Use	
1	Function display
2	Level of assistance
3	Unit of measure for speed
4	Display of rider's power output
5	Warning symbol
6	Driving light symbol
7	Push assist symbol
8	Charge status indicator
9	Motor power output screen
10	Current speed

Table 12:

On-screen indicators overview

## Description

### Level of assistance

The higher the selected level for assistance, the more the drive system assists the rider when pedalling. The following levels of assistance are available.





Display	Level of assistance
	off
	1
	2
	3
	4

Table 13:

Display of levels of assistance

### Current speed

In the system settings, you can select whether the speed is displayed in kilometres or miles.

### Function display

The function display shows three different items of information:

- Journey information,
- System settings and data, and
- System messages.

## Description

**Journey information**

Depending on the type of bicycle, the function display may show up to eight items of journey information. The displayed journey information can be switched.

Screen display	Function
CLOCK	Current time, displayed in hh:mm
TRIP DISTANCE	Distance travelled since the last reset, displayed in kilometres or miles
TRIP CALORIES	Calories burned since the last reset, displayed in calories
TRIP TIME	Time elapsed since the last reset, displayed in hh:mm
AVG. SPEED	Average speed since the last reset, displayed in kilometres per hour or miles per hour
MAX. SPEED	Maximum speed travelled since the last reset, displayed in kilometres per hour or miles per hour
TOTAL DISTANCE	Total distance travelled, displayed in kilometres or miles
TOTAL TIME	Travelled time, displayed in hh:mm

Table 14:

**Journey information****System settings and data**

In order to see the system settings, the rider has to call up the system settings. The rider can change the values of the system settings.

Screen display	Function
RESET TRIP	Set trip time, calories burned, distance and average speed to 0
RESET ALL	Set all values incl. total distance and total trip time to 0
DATE	DD/MM/YY
TIME FORMAT	24/12
TIME	hh/mm
LANGUAGE	German/English
METRIC/IMPERIAL	km/mi

Table 15:













**Changeable system settings**

## Description

### Charge status indicator

The charge status indicator consists of 5 segments. Every segment shows 20% of the battery charge status.

If the charge status is <20%, the charge status indicator starts to flash. If the charge status is <5%, the charge status indicator disappears. The motor assistance will be switched off in order to ensure that lighting can be used for another two hours.

When charging		When riding	
	0 - 19%		80 - 100%
	20 - 39%		60 - 79%
	40 - 59%		40 - 59%
	60 - 79%		20 - 39%
	80 - 99%		5 - 19%
	100%		< 5 - 0% emergency operation, motor off

**Table 16:** Battery charge status indicator

### System message

The drive system monitors itself continuously and if an error is detected, it is indicated by a system message. The system may switch off automatically depending on the type of error. There is a table of system messages in the Appendix.

### 3.6.5 Operating element

The operating element has six buttons.

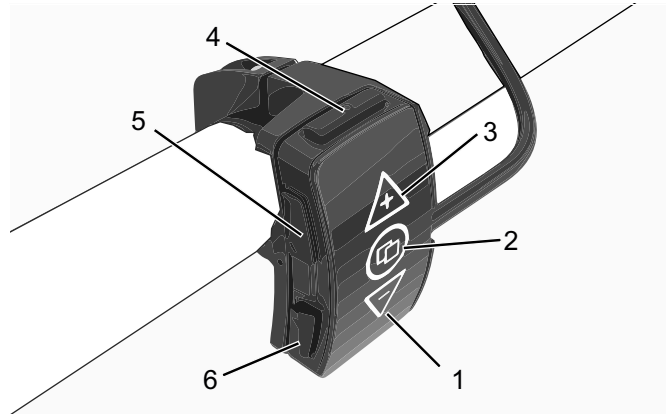

Figure 17: Operating element overview

	Symbol	Designation
1	–	Minus button
2		Info button
3	+	Plus button
4		On-Off button
5		Driving light button
6		Push assist button

Table 17: Operating element overview

## Technical data

### 4 Technical data

#### Bicycle

<b>Transportation temperature</b>	5 °C–25 °C
<b>Ideal transportation temperature</b>	10 °C–15 °C
<b>Storage temperature</b>	5 °C–25 °C
<b>Ideal storage temperature</b>	10 °C–15 °C
<b>Operation temperature</b>	5 °C–35 °C
<b>Working environment temperature</b>	15 °C–25 °C
<b>Charging temperature</b>	10 °C–30 °C
<b>Power output/system</b>	250 W (0.25 kW)
<b>Shut-off speed</b>	25 km/h

Table 18:

#### Bicycle technical data

#### Motor

<b>Dimensions (mm)</b>	213 x 150 x 128
<b>Weight</b>	3400 g
<b>Nominal voltage</b>	36 V DC
<b>Protection class</b>	IP56
<b>Max. torque</b>	90 Nm
<b>Continuous power rating</b>	250 W
<b>Assistance up to</b>	25 km/h
<b>Working temperature</b>	-10 - +50 °C

Table 19:

#### Motor technical data



Technical data

**Evo 650 rechargeable battery**

Transportation temperature	5 °C–25 °C
Ideal transportation temperature	10 °C–15 °C
Storage temperature	5 °C–25 °C
Ideal storage temperature	10 °C–15 °C
Charging ambient temperature	10 °C–30 °C

Table 20:

**Rechargeable battery technical data**

**SuperCore rechargeable battery**

Voltage	37 V / 42.0 V
Energy	750 W / 20 Ah
Transportation temperature	5 °C–25 °C
Ideal transportation temperature	10 °C–15 °C
Storage temperature	5 °C–25 °C
Ideal storage temperature	10 °C–15 °C
Charging ambient temperature	10 °C–30 °C

Table 21:

**Rechargeable battery technical data**

**Display and control panel**

Dimensions (mm)	Display: 44 x 62.5 x 8 Control panel: 18 x 46 x 19.75 Display area: 38 x 50
Weight (g)	Display unit: 67
Nominal voltage	36 V DC

Table 22:

**Operating element technical data**

## Technical data

<b>Protection class</b>	IP65
<b>Working temperature</b>	-10 - +60 °C
<b>Storage temperature range</b>	-20 - +85 °C

**Table 22:** Operating element technical data

### USB port

<b>Charge voltage</b>	5 V
<b>Charging current</b>	max. 500 mA

**Table 23:** USB port technical data

### Emissions

<b>A-weighted emission sound pressure level</b>	< 70 dB(A)
<b>Total vibration level for the hands and arms</b>	< 2.5 m/s <sup>2</sup>
<b>Highest effective value of weighted acceleration for the entire body</b>	< 0.5 m/s <sup>2</sup>

**Table 24:** Emissions from the bicycle\*

\*The safety requirements as per Electromagnetic Compatibility Directive 2014/30/EU have been met. The bicycle and the charger can be used in residential areas without restriction.

### Tightening torque

<b>Axle nut tightening torque</b>	35 Nm - 40 Nm
<b>Handlebars clamping screw maximum tightening torque*</b>	5 Nm - 7 Nm

**Table 25:** Tightening torque values  
\*if there is no other data on the component

## 5 Transportation, storage and assembly

### 5.1 Transportation



#### Crash caused by unintentional activation

There is a risk of injury if the drive system is activated unintentionally.

- ▶ Remove the battery before the bicycle is transported.



#### Risk of fire and explosion due to high temperatures

Excessively high temperatures will damage the battery. Batteries may self-ignite and explode.

- ▶ Never expose batteries to sustained direct sunlight.



#### Oil leak if no transport securing device

The brake securing device prevents the brakes from being applied accidentally during transport. This could cause irreparable damage to the brake system or an oil leak, which will harm the environment.

- ▶ Never pull the brake lever when the wheel has been dismantled.
- ▶ Always use the transport securing system when transporting dismantled wheels.

#### NOTICE

If the bicycle is lying flat, oil and grease may leak from the bicycle.

If the shipping box with a bicycle is lying flat or on one end, it does not provide the *frame* and the wheels with adequate protection from damage.

- ▶ Only transport the bicycle in an upright position.

## Transportation, storage and assembly

### NOTICE

Bicycle rack systems which secure the bicycle standing on its head by the *handlebars* or *frame*, generate inadmissible forces on the components during transportation. This can cause the supporting parts to break.

- ▶ Never use bicycle rack systems which secure the bicycle standing on its head by the *handlebars* or *frame*.
- ▶ Take into account the ready-to-use bicycle's weight when transporting it.
- ▶ Remove the *display* and the batteries before transporting the bicycle.
- ▶ Protect the electrical components and connections on the bicycle from the elements with suitable protective covers.
- ▶ Remove accessories, for example drinking bottles, before transportation of the bicycle.
- ▶ When transporting by car, you must use a suitable bicycle rack system.



The specialist dealer will advise you on how to select a suitable rack system properly and how to use it safely.

- ▶ Transport the bicycle in a dry, clean place where it is protected from direct sunlight.



When shipping the bicycle, we recommend that you have the bicycle partially dismantled in the proper manner and packaged by the specialist dealer.

### 5.1.1 Transporting the battery

Batteries are subject to hazardous goods regulations. Undamaged batteries may be transported by private persons in road traffic. Commercial transport requires compliance with regulations concerning packaging, labelling and the transportation of hazardous goods. Open contacts must be covered and the battery securely packaged. The parcel service must be made aware of the presence of hazardous goods in the packaging.

### 5.1.2 Using the transport securing system

- ▶ Insert the transport securing devices between the brake linings.
- ⇒ The transport securing device is squeezed between the two linings.

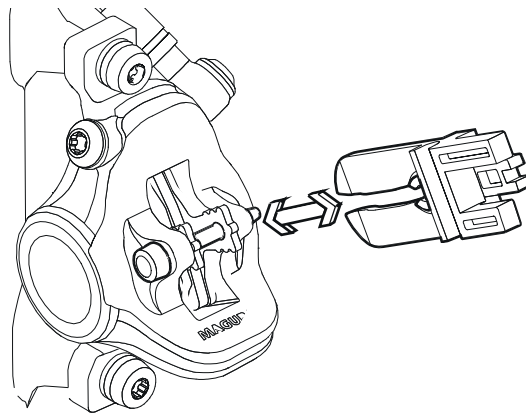

Figure 18: Fastening the transport securing device

Transportation, storage and assembly

**5.2 Storing**



**Risk of fire and explosion due to high temperatures**

Excessively high temperatures will damage batteries. Batteries may self-ignite and explode.

- ▶ Protect batteries against heat.
- ▶ Never expose batteries to sustained direct sunlight.



If the bicycle is lying flat, oil and grease may leak from the bicycle.

If the shipping box with a bicycle is lying flat or on one end, it does not provide the *frame* and the wheels with adequate protection from damage.

- ▶ Only store the bicycle in an upright position.
- ✓ If the bicycle features a hydraulic seat post, fix only the lower seat post or the frame into a fitting stand to prevent damage to the upper seat post and the seat post lever.
- ✓ Never place a bicycle with a hydraulic seat post upside down on the floor; otherwise you, will damage the seat post lever.
- ✓ Store the bicycle, battery and charger in a dry, clean location.

<b>Storage temperature</b>	5 °C–25 °C
<b>Ideal storage temperature</b>	10 °C–15 °C

**Table 26:**

**Storage temperature for batteries, the bicycle and charger**

## Transportation, storage and assembly

### 5.2.1 Break in operation

#### NOTICE

The battery discharges when not in use. This can cause irreparable damage to the battery.

- ▶ The battery must be recharged every 8 weeks.

#### NOTICE

The battery may become damaged if it is connected permanently to the charger.

- ▶ Never connect the battery to the charger permanently.

#### NOTICE

The display battery discharges when it is not in use. This can cause it to be irreparably damaged.

- ▶ Recharge the display battery for at least 1 hour every 3 months.

If the bicycle is to be removed from service for longer than four weeks, e.g. in winter, a break in operation has to be prepared.

#### 5.2.1.1 Preparing a break in operation

- ✓ Enable display storage mode.
- ✓ Remove the battery from the bicycle.
- ✓ Charge the battery to around 60% (three to four LEDs of the charge status indicator light up).
- ✓ The bicycle has to be cleaned with a damp cloth and preserved with wax spray. Never wax the friction surfaces of the brake.
- ✓ Before longer periods without use, it is recommendable to have your specialist dealer carry out servicing and basic cleaning and apply preservative agent.

#### 5.2.1.2 Taking out of operation

- ▶ Store the bicycle, battery and charger in a dry, clean environment.
- ▶ Check the charge status of the battery after 8 weeks. If only one LED on the charge status indicator lights up, recharge the battery to around 60%.

## Description

### 5.3 Brake system

The bicycle's brake system comprises a hydraulic rim brake on both the front and rear wheel.

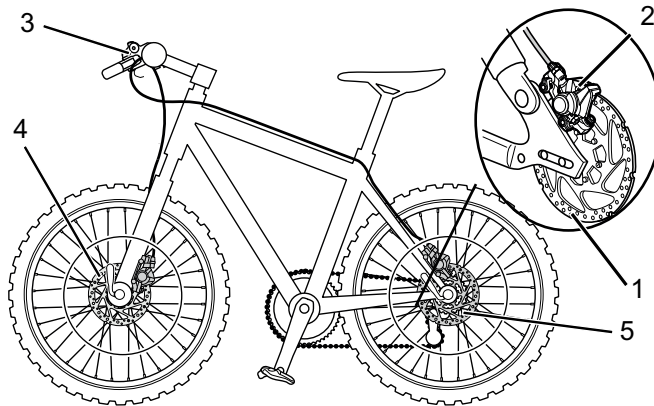

**Figure 19:** Bicycle brake system with a disc brake, example

- 1 Brake disc
- 2 Brake calliper with brake linings
- 3 *Handlebars with brake levers*
- 4 Front wheel brake disc
- 5 Rear wheel brake disc

On a bicycle with a disc brake, the brake disc is screwed permanently to the *hub* of the wheel.

The brake lever is pulled to increase brake pressure. The brake fluid is used to transfer pressure through the brake lines to the cylinders in the brake calliper. The braking force is boosted by a speed reduction and applied to the brake linings. These apply the brake disc mechanically. If the brake lever is pulled, the brake linings are pressed against the brake disc, and the movement of the wheel is decelerated until it comes to a stop.



## Transportation, storage and assembly

**5.4****Assembly****Crushing caused by unintentional activation**

There is a risk of injury if the drive system is activated unintentionally.

- ▶ Remove the battery if it is not absolutely necessary for assembly.



- ✓ Assemble the bicycle in a clean and dry environment.
- ✓ The working environment temperature should be between 15 °C and 25 °C.

**Working environment temperature**

15 °C–25 °C

Table 27:

**Working environment temperature**

- ✓ If a fitting stand is used, it must be approved for a maximum weight of 30 kg.
- ✓ To reduce the weight, we recommend that you always disconnect the battery from the bicycle when using the fitting stand.

**5.4.1****Required tools**

The following tools are required to assemble the bicycle:

- Knife
- Hexagon socket spanner 2 (2.5 mm, 3 mm, 4 mm, 5 mm, 6 mm and 8 mm)
- Torque wrench with working range between 5 and 40 Nm
- Twelve-point square socket T-25
- Ring spanner (8 mm, 9 mm, 10 mm, 13 mm, 14 mm and 15 mm) and
- Cross, flat head and ordinary screwdriver.

## Transportation, storage and assembly

### 5.4.2

### Unpacking



**CAUTION**

#### Hand injuries caused by cardboard packaging

The shipping carton is closed with metal staples. There is a risk of puncture wounds and cuts when unpacking and crushing the packaging.

- ▶ Wear suitable hand protection.
- ▶ Remove the metal staples with pliers before the shipping carton is opened.

The packaging material consists mainly of cardboard and plastic film.

- ▶ The packaging has to be disposed of in accordance with the regulations of the authorities.

### 5.4.3

#### Scope of delivery

The bicycle was completely assembled in the factory for test purposes and then dismantled for transportation.

The bicycle is 95–98% pre-assembled. The scope of delivery includes:

- the pre-assembled bicycle
- the front wheel
- the pedals
- quick release (optional)
- the charger
- the operating instructions.

The battery is supplied separately from the bicycle.

#### 5.4.4

### Commissioning



#### Fire and explosion caused by incorrect charger

Batteries which are recharged with an unsuitable charger may become damaged internally. This may result in fire or an explosion.

- ▶ Only ever use the battery with the supplied charger.
- ▶ Mark the supplied charger and these operating instructions clearly to prevent mix-ups – with the bicycle *frame number* or *type number*, for example.

Since initial commissioning of the bicycle requires special tools and specialist knowledge, only trained specialist staff may perform initial commissioning.

Experience has shown that a bicycle which has not yet been sold, is spontaneously handed to consumers as soon as it appears ready to ride.

- ▶ For this reason, every bicycle must be prepared, so that it is fully ready for use immediately after being assembled.
- ▶ Staff should work through the initial commissioning check list to prepare the bicycle, so that it is ready to ride.

## Transportation, storage and assembly

### Initial commissioning check list

- Check battery.
- The battery is partially charged when delivered. Fully charge the battery to ensure full power.
- Mount the wheels, quick release and pedals.
- Re-adjust the quick release clamping force if necessary.
- Thoroughly degrease the brake discs in disc brakes or the brake sides and linings in rim brakes with brake cleaner or spirit.
- Place handlebars, stem and saddle in the functional position and check they are firmly in place.
- Check all the components to make sure that they are firmly in place. Check all the settings and the tightening torque on the axle nuts.
- Check the entire cable harness to make sure that it is routed properly:
  - You must prevent the cable harness from coming into contact with moving parts.
  - The cable routes must be smooth and free from sharp edges.
  - Moving parts must not apply any pressure or tension to the cable harness.
- Check the drive system, the light equipment and the brakes to make sure that they are fully functional and effective.
- Adjust the headlight.
- Set the drive system has to the national language and the appropriate system of measurement.
- Check the software version of the drive system and update it as necessary.
- Take a test drive to check the brake system, gear shift and the electric drive system.

## Transportation, storage and assembly

### 5.4.4.1

#### Checking the battery



#### Fire and explosion due to defective battery

The safety electronics on damaged or faulty batteries may fail. The residual voltage can cause a short circuit. Batteries may self-ignite and explode.

- ▶ Never charge a defective battery.

The battery must be checked before it is charged for the first time.

- ▶ Press the *On-Off button (battery)*.
- ⇒ If none of the LEDs on the operating and charge status indicator light up, the battery may be damaged.
- ⇒ The battery can be charged if at least one of the LEDs on the operating and charge status indicator is fully lit up, but not if all of them are.
- ▶ Once the battery has been charged, insert it into the bicycle.

## Transportation, storage and assembly

### 5.4.5 Mounting the wheel in the Suntour fork *Alternative*

#### 5.4.5.1 Mounting the wheel with screw-on axle (15 mm) *Alternative*

- ▶ Insert the axle completely on the drive side.

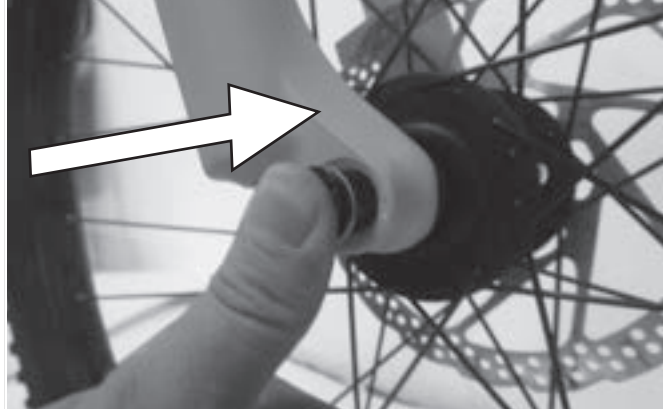

Figure 20: Fully inserting the axle

- ▶ Tighten the axle with a 5 mm hexagon socket spanner to 8–10 Nm.

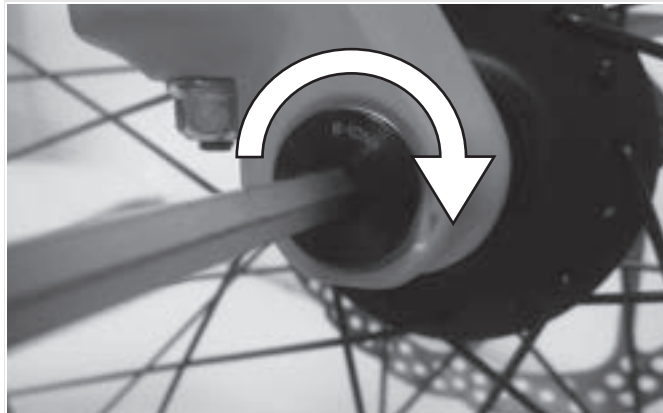

Figure 21: Tightening the axle

## Transportation, storage and assembly

- ▶ Insert the securing screw on the non-drive side.

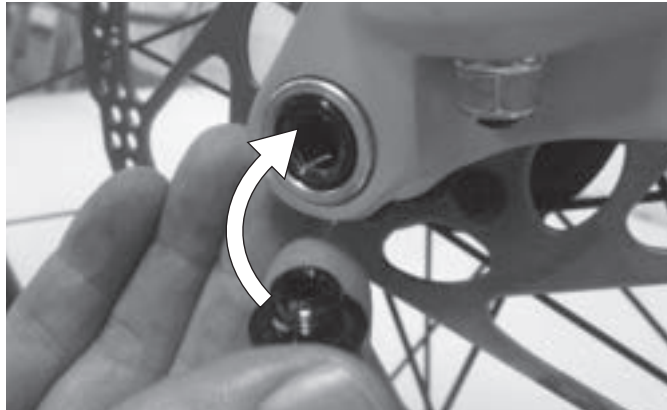

Figure 22:

Pushing the quick release lever into the axle

- ▶ Tighten the securing screw with a 5 mm hexagon socket spanner to 5–6 Nm.

⇒ The lever is mounted.



Figure 23:

Tightening the securing screw

## Transportation, storage and assembly

### 5.4.5.2

#### Mounting the wheel with screw-on axle (20 mm) *Alternative*

- ▶ Insert the axle completely on the drive side.

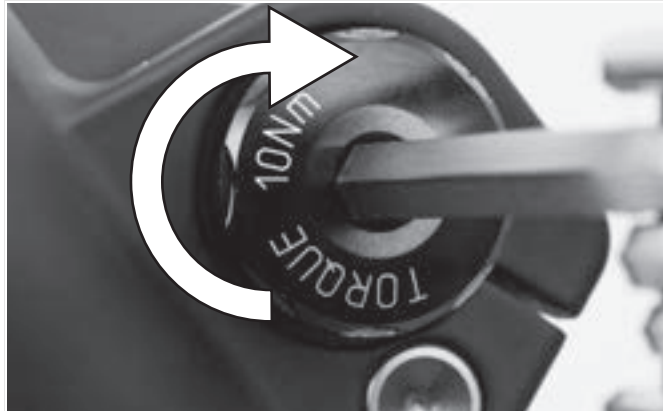

Figure 24:

Tightening the inserted axle

- ▶ Tighten the securing clip with a 4 mm hexagon socket spanner to 7 Nm.

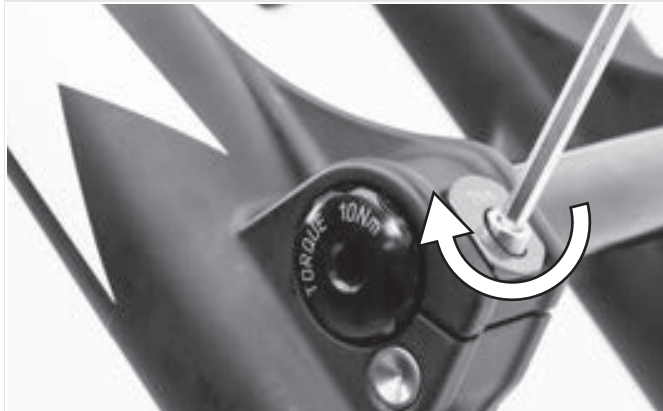

Figure 25:

Tightening the axle



## Transportation, storage and assembly

## 5.4.5.3

**Mounting the wheel with a quick release axle****Alternative****CAUTION****Crash caused by loose quick release axle**

A faulty or incorrectly installed quick release axle may become caught in the brake disc and block the wheel. This will cause a crash.

- ▶ Never fit a defective quick release axle.

**CAUTION****Crash caused by faulty or incorrectly installed quick release axle**

The brake disc becomes very hot during operation. Parts of the quick release axle may become damaged as a result. The quick release axle becomes loose. This will result in a crash and injuries.

- ▶ The quick release axle and the brake disc must be opposite one another.

**CAUTION****Crash caused by incorrectly set quick release axle**

Insufficient clamping force will cause a detrimental transmission of force. The suspension fork or the quick release axle may break. This will result in a crash and injuries.

- ▶ Never fasten a quick release axle with a tool, such as a hammer or pliers.

## Transportation, storage and assembly

- ▶ Insert the axle into the hub on the drive side.  
Clamping version II.

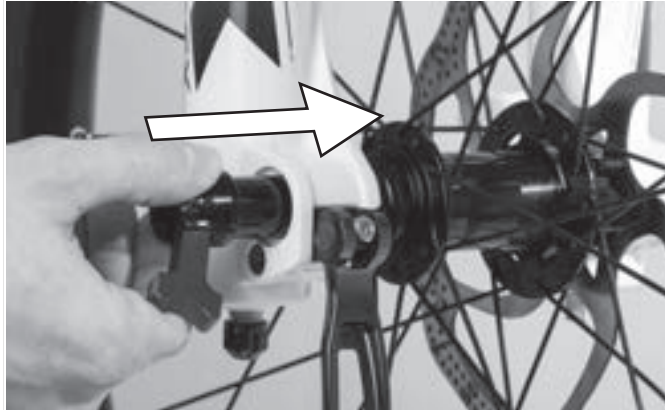

**Figure 26:** Pushing the axle into the hub

- ▶ Tighten the axle with the red handle.

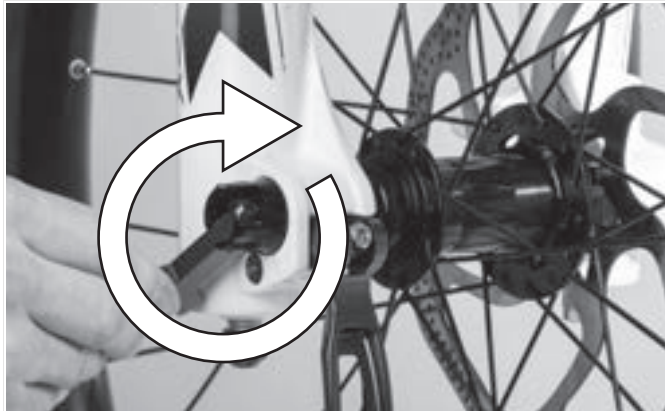

**Figure 27:** Tightening the axle

Transportation, storage and assembly

► Push the quick release lever into the axle.

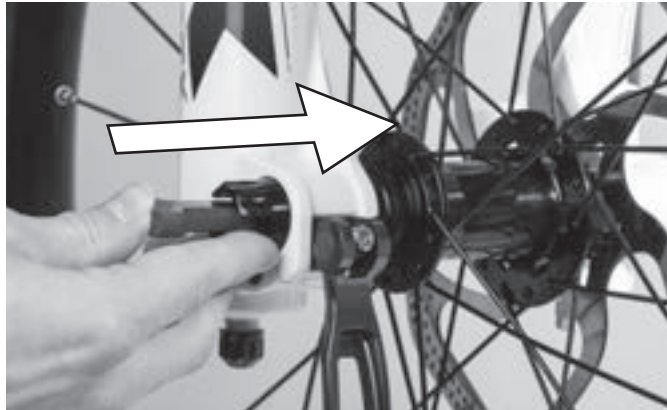

Figure 28:

Pushing the quick release lever into the axle

► Reverse the quick release lever.

⇒ The lever is secured.

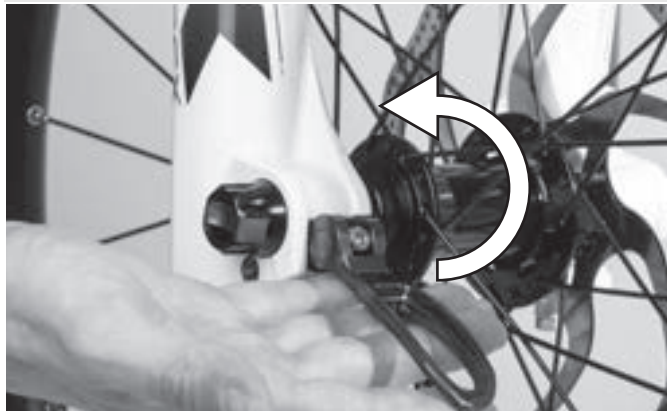

Figure 29:

Securing the lever

## Transportation, storage and assembly

- ▶ Check the position and clamping force of the quick release lever. The quick release lever must be flush with the lower housing. You must be able to see a slight impression on the palm of your hand when you close the quick release lever.



Figure 30:

**Perfect position for the clamping lever**

- ▶ Use a 4 mm hexagon socket spanner to adjust the clamping lever clamping force if required. Afterwards, check the quick release lever position and clamping force.

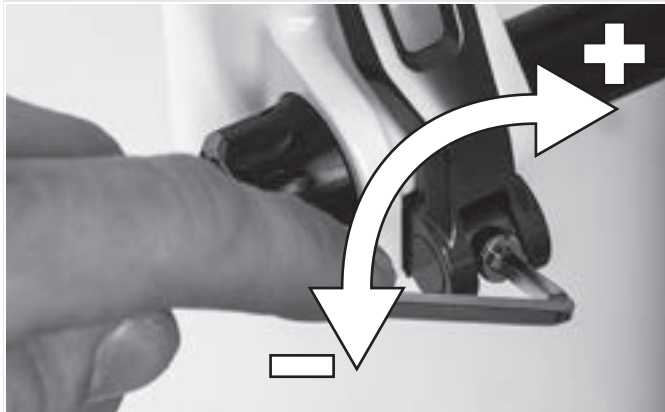

Figure 31:

**Adjusting the quick release clamping force**

**5.4.6****Mounting the wheel with a quick release  
Alternative****CAUTION****Crash caused by unfastened quick release**

A faulty or incorrectly installed quick release may become caught in the brake disc and block the wheel. This will cause a crash.

- ▶ Never fit a defective quick release.

**CAUTION****Crash caused by faulty or incorrectly installed  
quick release**

The brake disc becomes very hot during operation. Parts of the quick release may become damaged as a result. The quick release comes loose. This will result in a crash and injuries.

- ▶ The front wheel quick release lever and the brake disc must be situated on opposite sides.

**CAUTION****Crash caused by incorrectly set clamping force**

Excessively high clamping force will damage the quick release and cause it to lose its function.

Insufficient clamping force will cause a detrimental transmission of force. The suspension fork or the quick release may break. This will result in a crash and injuries.

- ▶ Never fasten a quick release using a tool (e.g. hammer or pliers).
- ▶ Only use the clamping lever with the specified set clamping force.

## Transportation, storage and assembly

- ▶ Before mounting, ensure that the quick release flange is extended. Open the lever completely.

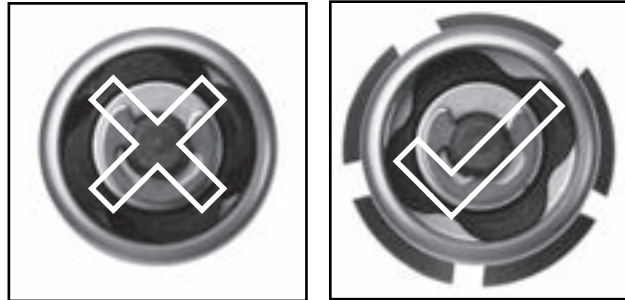

Figure 32:

### Open and closed flange

- ▶ Push in the quick release until you hear a clicking sound. Make sure that the flange is extended.

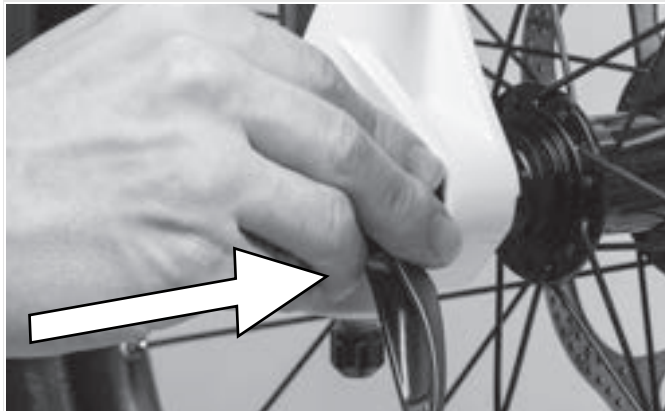

Figure 33:

### Pushing the quick release in

## Transportation, storage and assembly

- ▶ Adjust the clamping with a half-open clamping lever until the flange reaches the fork end.

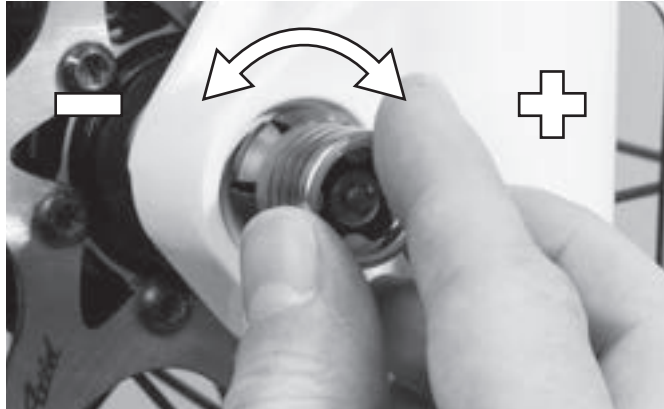

Figure 34:

### Adjusting the clamping

- ▶ Fully close the quick release. Check the quick release to ensure it is firmly in place and adjust on the flange if necessary.

⇒ The lever is secured.



Figure 35:

### Closing the quick release

## Transportation, storage and assembly

### 5.4.6.1

#### Checking the stem and handlebars

##### Checking connections

- ▶ Stand in front of the bicycle to check whether the handlebars, stem and fork shaft are firmly attached to one another. Clamp the front wheel between your legs. Grasp the handlebar grips. Try to twist the handlebars towards the front wheel.

⇒ The stem must not move or twist.

##### Firm hold

- ▶ Place your entire body weight on the handlebars with the quick release lever closed to check that the stem is firmly in place.

⇒ The handlebars shaft must not move downwards in the fork shaft.

- ▶ If the handlebars shaft should move in the fork shaft, increase the quick release lever tensioning. To do so, turn the knurled nut slightly in a clockwise direction with the quick release lever open.

- ▶ Close the lever and check the stem is firmly in position.



### Checking the headset backlash

- ▶ To check the handlebar headset backlash, close the quick release lever on the stem. Place the fingers of one hand on the upper headset cup, pull the front wheel brake with the other hand and try to push the bicycle backwards and forwards.
- ▶ The headset cup halves must not move towards one another while you are doing this. Note that there may be noticeable backlash due to worn-out bearing bushes or brake lining backlash in suspension forks and disc brakes.
- ▶ If there is headset backlash in the steering headset, you must adjust it as soon as possible; otherwise, the headset will become damaged. You must make the adjustment as described in the stem manual.

### 5.4.7

### Sale of the bicycle

- ▶ Fill out the data sheet on the first page of the operating instructions.
- ▶ Adjust the bicycle to the rider.
- ▶ Set the *stand* and the *shifter*, and show the purchaser the settings.
- ▶ Instruct the operator or rider how to use all the functions of the bicycle.

Before the first ride

---

## 6 Before the first ride

---



### Crash caused by incorrectly adjusted torques

If a screw is fastened too tightly, it may break. If a screw is not fastened enough, it may loosen. This will result in a crash and injuries.

- ▶ Always observe the indicated torques on the screw or in the operating instructions.
- 

Only a correctly adjusted bicycle will guarantee you the desired ride comfort and health-promoting activity. Therefore adjust the *saddle*, the *handlebars* and the *suspension* to your body and your preferred riding style before the first ride.

### 6.1 Adjusting the saddle

#### 6.1.1 Adjusting the saddle tilt

The saddle tilt must be adjusted to the seat height, the saddle and handlebar position, and the saddle shape to ensure an optimum fit. The seating position can be optimised in this way if needed. First, readjust the saddle after finding the handlebar position you prefer.

---

**Before the first ride**

- ⇒ Place the saddle tilt in the horizontal position to adjust the bicycle to your needs for the first time.

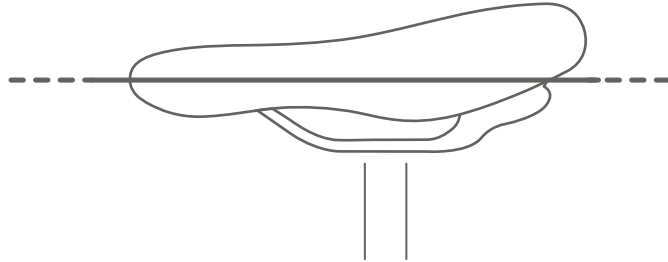

**Figure 36:** Horizontal saddle tilt

### 6.1.2

#### Determining the seat height

- ✓ To determine the seat height safely, either push the bicycle near to a wall, so that you can lean on the wall to support yourself or ask another person to hold the bicycle for you.
  - ▶ Climb onto the bicycle.
  - ▶ Place your heel on the pedal and extend your leg, so that the pedal is at the lowest crank rotation point.
- ⇒ The rider sits straight on the saddle if the seat is at an optimum height. If this is not the case, you can adjust the length of the seat post to your needs.

## Before the first ride

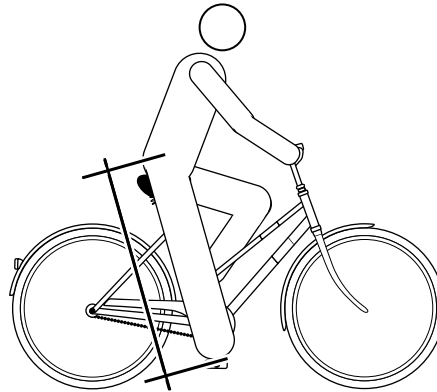

Figure 37: Optimal saddle height

### 6.1.3

#### Adjusting the seat height with quick release

- Open the quick release on the seat post to change the seat height. To do so, pull the clamping lever away from the seat post.

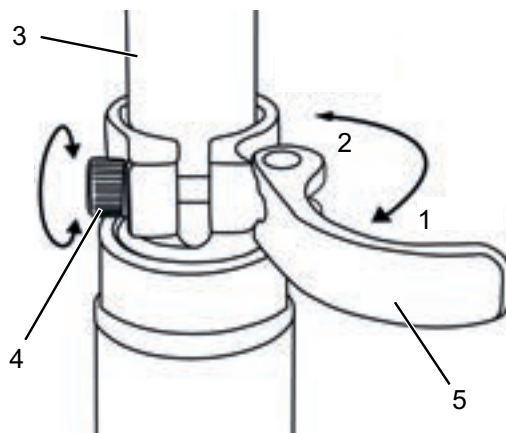

Figure 38: Seat post quick release (3) with clamping lever (5) and setting bolt (4) in the open position (1) and in the direction of the closed position (2)

Before the first ride

- ▶ Set the seat post at the required height.



### Crash caused by an excessively high seat post setting

A *seat post* with is set too high will cause the *seat post* or the *frame* to break. This will result in a crash and injuries.

- ▶ Do not pull the seat post out of the frame beyond the minimum insertion depth marking.

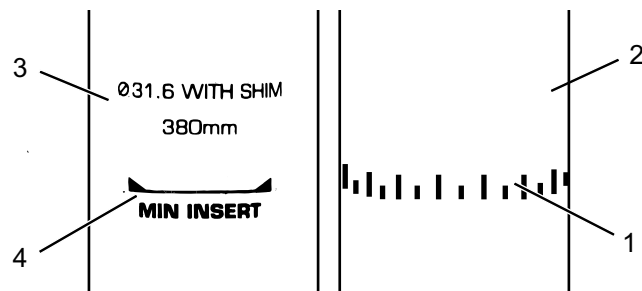

Figure 39:

Detailed view of the seat post – examples of the minimum insertion depth marking

- ▶ To close it, push the *seat post clamping lever* as far as it will go into the *seat post*.
- ▶ Check the *clamping force of the quick releases*.

## Before the first ride

### 6.1.4 Setting the height-adjustable seat post

- ▶ When using your seat post for the first time, you must give it a firm push downwards to set it in motion. This is due to the natural tendency of the seal to repel oil from the seal surface. You only need to do this before the first use or after a longer period of non-use. Once you have displaced the post through its deflection, the oil spreads on the seal and the post begins to function normally.

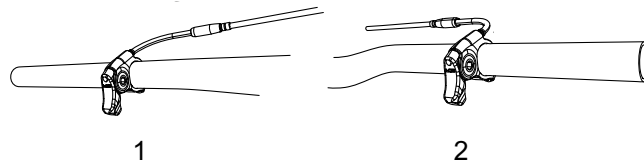

Figure 40: The seat post activation lever can be mounted either on the left (1) or the right (2) side of the handlebars

#### 6.1.4.1 Lowering the saddle

- ✓ To lower the saddle, press your hand down on the saddle or sit on the saddle.
- ▶ Press the seat post activation lever and hold it down.
- ▶ Release the lever once you have reached the required height.

#### 6.1.4.2 Raising the saddle

- ▶ Pull the seat post activation lever.
- ▶ Remove any pressure on the saddle and release the lever once you have reached the required height.

### 6.1.5 Adjusting the seat position

The saddle can be shifted on the saddle frame. The right horizontal position ensures an optimal leverage position for legs. This prevents knee pain and painful incorrect pelvis positions. If you have displaced the saddle more than 10 mm, you then need to adjust the saddle height again since both settings affect one another.

- ✓ To adjust the seat position safely, either push the bicycle near to a wall, so that you can lean on the wall to support yourself or ask another person to hold the bicycle for you.
- ▶ Climb onto the bicycle.
- ▶ Place the pedals into the vertical position (3 o'clock position) with your feet.
- ⇒ The rider is sitting in the optimal sitting position if the knee cap perpendicular line runs through the pedal axle. If the perpendicular line crosses behind the pedal, bring the saddle forward. If the perpendicular line crosses in front of the pedal, bring the saddle back. Move the saddle within its permitted displacement range only (marked on the saddle stay).

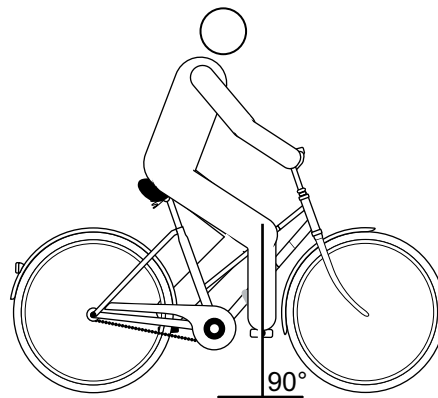

Figure 41: Knee cap perpendicular line

Before the first ride

## 6.2



### Adjusting the handlebars

- ✓ The handlebars must only be adjusted while the bicycle is stationary.
- ▶ Unfasten and adjust the designated screw connections, and clamp them with the maximum tightening torque for the clamping screws of the handlebars.

**Maximum tightening torque for the clamping screws of the handlebars\***

5 Nm - 7 Nm

\*if there is no other data on the component

Table 28:

Handlebars clamping screw maximum tightening torque

### Adjusting the stem



#### Crash caused by loose stem

Incorrectly fastened screws may come loose due to impact. The stem may no longer be firmly fixed in its position as a result. This will result in a crash and injuries.

- ▶ Check the handlebars and the quick release system are firmly in position after the first two hours of riding.



Before the first ride

## 6.2.1 Adjusting the height of the handlebars



### Crash caused by incorrectly set clamping force

Excessively high clamping force will damage the quick release and cause it to lose its function. Insufficient clamping force will cause a detrimental transmission of force. This can cause components to break. This will result in a crash and injuries.

- ▶ Never fasten a quick release using a tool (e.g. hammer or pliers).
  - ▶ Only use the clamping lever with the specified set clamping force.
- 
- ▶ Open the clamping lever.
  - ▶ Pull the locking lever on the stem up, and simultaneously pivot the handlebars into the desired position.
- ⇒ You feel the locking lever click into place.
- ▶ Pull out the handlebars to the required height.
  - ▶ Lock the quick release.

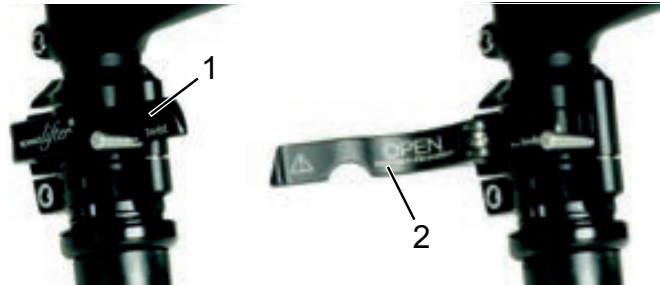

Figure 42:

Open (2) and closed (1) clamping lever on the stem; by.schulz speedlifter used as an example

---

## Before the first ride

---

### 6.2.2 Turning the handlebars to the side *Alternative*



---

#### **Crash caused by incorrectly set clamping force**

Excessively high clamping force will damage the quick release and cause it to lose its function.

Insufficient clamping force will cause a detrimental transmission of force. This will result in a crash and injuries.

- ▶ Never fasten a quick release using a tool (e.g. hammer or pliers).
  - ▶ Only use the clamping lever with the specified set clamping force.
- 
- ▶ Open the clamping lever.
  - ▶ Pull the locking lever on the stem up, and simultaneously pivot the handlebars into the desired position.
- ⇒ You feel the locking lever click into place.
- ▶ Pull out the handlebars to the required height.
  - ▶ Lock the quick release.
- 

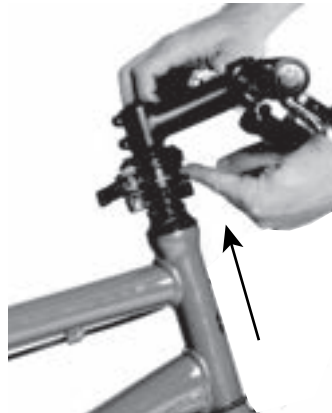

**Figure 43:** Pulling locking lever upwards; by.schulz speedlifter used as an example

Before the first ride

### 6.2.2.1

#### Checking the clamping force of the quick releases

- ▶ Open and close the quick releases on the stem or the seat post.
- ⇒ The clamping force is sufficient if the clamping lever can be moved easily from the open final position into the middle and has to be pressed with the fingers or base of the thumb from the middle point onwards.

### 6.2.2.2

#### Adjusting the quick release clamping force

- ▶ If the *clamping lever on the handlebars* cannot be moved into its final position, screw out the *knurled nut*.
- ▶ Tighten the *knurled nut* on the seat post if the *clamping lever's* clamping force is not sufficient.



If you are unable to set the clamping force, the specialist dealer will need to check the quick release.

## 6.3

### Adjusting the brake lever

#### 6.3.1

#### Adjusting the pressure point on a Magura brake lever



**WARNING**

#### Brake failure due to incorrect setting

If the pressure point is set with brakes where the brake lining and brake disc have reached their wear limit, the brakes may fail and cause an accident with injury.

- ▶ Before you set the pressure point, ensure that the brake lining and brake disc have not reached their wear limit.

The pressure point setting is adjusted using the twist knob.

- ▶ Turn the twist knob towards the plus (+) symbol.

## Before the first ride

- ⇒ The brake lever moves closer to the handlebar grip. Re-adjust the grip distance as necessary.
- ⇒ The lever pressure point activates sooner.

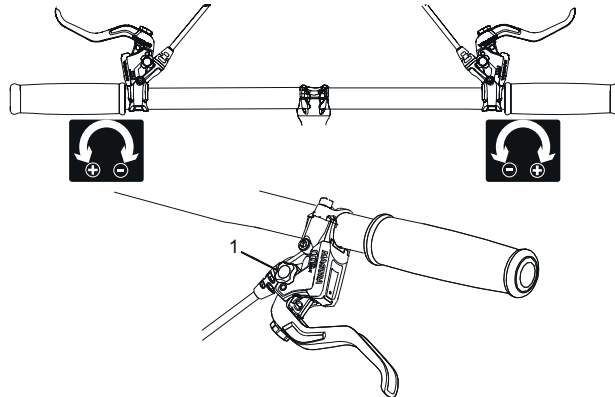

Figure 44: Using the twist knob (1) to adjust the pressure point

### 6.3.2

## Adjusting the grip distance



### WARNING

### Crash caused by incorrectly set grip distance

If brake cylinders are set incorrectly or installed wrongly, the braking power may be lost at any time. This may cause you to fall from the bicycle and injure yourself.

- ▶ Once the grip distance has been set, check the position of the brake cylinder and adjust it as necessary.
- ▶ Never correct the brake cylinder position without special tools. Have a specialist dealer correct it.



The brake lever grip distance can be adjusted to ensure that it can be reached more easily. Contact your specialist dealer if the brake handle is too far from the handlebars or is hard to use.

Before the first ride

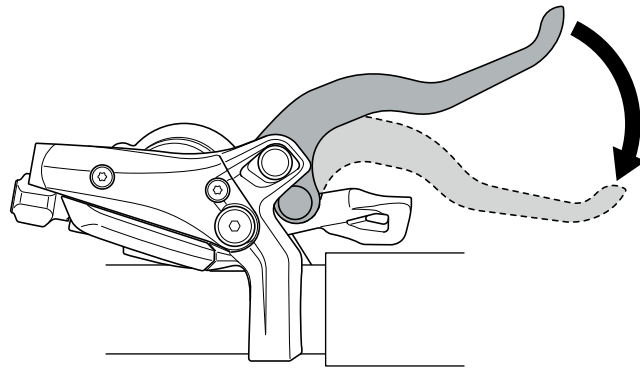

Figure 45: Brake lever grip distance

### 6.3.2.1

#### Adjusting the grip distance on a Magura brake lever Alternative

Use a T25 TORX® wrench to turn the setting screw to adjust the grip distance.

- ▶ Turn the setting screw in the minus (–) direction.  
⇒ The brake lever moves closer to the handlebar grip.
- ▶ Turn the setting screw in the plus (+) direction.  
⇒ The brake lever moves away from the handlebar grip.

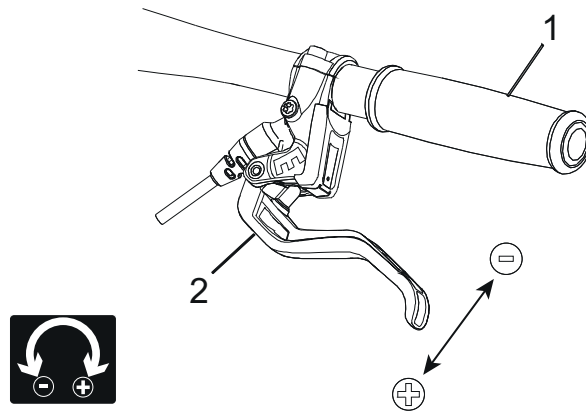

Figure 46: Using the setting screw (2) to adjust the distance from the brake lever to the handlebar grip (1)

Before the first ride

---

## 6.4 Adjusting the suspension

---



### CAUTION

#### Crash caused by incorrectly set suspension

---

If the suspension is adjusted incorrectly, the fork may become damaged, so that problems may occur when steering. This will result in a crash and injuries.

- ▶ Never ride the bicycle without air in the air suspension fork.
  - ▶ Never use the bicycle without adjusting the suspension fork to the rider's weight.
- 

### NOTICE

- ▶ Settings on the chassis change riding performance significantly. You need to get used to the bicycle and break it in to prevent accidents.
- 

The adjustment shown here represents a basic setting. The rider should change the basic setting to suit the surface and his/her preferences.

- ▶ It is advisable to make a note of the basic setting. This way, it can be used as the starting point for subsequent, optimised settings and to safeguard against unintentional changes.

## 6.4.1 Adjusting the negative deflection

Negative deflection is compression caused by the rider's weight, including equipment (such as a backpack), sitting position and frame geometry.

Each rider has a different weight and sitting position. Negative deflection depends on the rider's position and weight and should be between 15% and 30% of the maximum fork deflection, depending on the bicycle usage and preferences.

### 6.4.1.1 Adjusting the steel suspension fork negative deflection *Alternative*

You can adjust the fork by tensioning the spring to the rider's weight and their preferred riding style. It is not the coil spring hardness which is adjusted; it is its pre-tensioning. This reduces the fork's negative deflection when the rider sits on the bicycle.



**Figure 47:** Negative deflection setting wheel on the suspension fork crown

- ✓ Only adjust the negative deflection when the bicycle is stationary.

## Before the first ride

---

- ▶ The setting wheel may be located under a plastic cover on the suspension fork crown. Remove the plastic cover by pulling it off upwards.
- ▶ Turn the negative deflection setting wheel in a clockwise direction to increase the spring pre-tensioning.  
Turn the negative deflection setting wheel in an anti-clockwise direction to reduce it.
- ⇒ The ideal setting in relation to the weight of the rider has been achieved when the shock absorber deflects 3 mm under the stationary load of the rider.
- ▶ If applicable, re-attach the plastic cover after setting the suspension fork.

### 6.4.1.2

#### Adjusting the air suspension fork negative deflection *Alternative*

#### NOTICE

---

Riding without filling pressure will destroy the wheel suspension, the frame and the air suspension elements.

- ▶ Never ride without filling pressure in the air suspension elements.

#### NOTICE

---

A normal air pump cannot build up the required pressure with sufficient sensitivity.

- ▶ Use a special damper pump to adjust the filling pressure.

---

The air chamber valve can be used to adjust the fork suspension to the rider's weight and driving style.



### Adjusting the tyre pressure

- ▶ The tyre pressure determines the force required to press the fork together. If the tyre pressure is reduced, the fork slackens more and rebounds less.



Figure 48:

#### Screw caps in different designs

- ✓ Only adjust the tyre pressure when the bicycle is stationary.
- ▶ The air valve is located under a screw cap on the head of the left shock absorber. Unscrew and remove the screw cap.
- ▶ Adjust the air pressure as an initial value using a high-pressure damper pump and based on the tyre pressure table on the fork and the rider's weight.

## 6.5

### Retracting brake linings

New brake linings take time to break in and adjust to their final braking force.

- ▶ Accelerate bicycle to about 25 km/h.
- ▶ Brake bicycle until it comes to a halt.
- ▶ Repeat process 30–50 times.
- ▶ The brake linings and brake discs are now retracted and provide optimal braking power.

## Operation

---

# 7 Operation

---



### Crash caused by loose clothing

Laces, scarves and other loose items may become entangled in the spokes on the *wheels* and the *chain drive*. This may cause you to fall from the bicycle and injure yourself.

- ▶ Wear sturdy footwear and close-fitting clothing.



### Risk of fire and burning due to hot motor

The motor housing becomes hot when riding. Touching it may cause burns to the skin or other objects.

- ▶ Never touch the motor housing directly after riding.
- ▶ Never place the bicycle on a flammable surface (grass, wood, etc.) directly after use.



### Crash caused by soiling

Heavy soiling can impair the functions of the bicycle, for example, the function of the brakes. This may cause you to fall from the bicycle and injure yourself.

- ▶ Remove coarse soiling before riding.



### Crash caused by poor road conditions

Loose objects, such as branches and twigs, may become caught in the wheels and cause a crash with injuries.

- ▶ Be aware of the road conditions.
- ▶ Ride slowly and brake in good time.

## NOTICE

When riding downhill, high speeds may be reached. The bicycle is only engineered for exceeding a speed of 25 km/h briefly. In particular the *tyres* can fail if exposed to a continuous load.

- ▶ Decelerate the bicycle with the brakes if higher speeds than 25 km/h are reached.

**NOTICE**

Heat or direct sunlight can cause the *tyre pressure* to increase above the permitted maximum pressure. This can destroy the *tyres*.

- ▶ Never park the bicycle in the sun.
- ▶ On hot days, regularly check the *tyre pressure* and adjust it as necessary.

You can be ride the bicycle within a temperature range between 5 °C and 35 °C. The effectiveness of the drive system is restricted outside of this temperature range.

**Operation temperature** 5 °C–35 °C

Moisture penetrating at low temperatures may impair individual bicycle functions due to the open structural design.

- ▶ Always keep the bicycle dry and free from frost.
- ▶ If the bicycle is to be used at temperatures below 3 °C, the specialist dealer must carry out an inspection and prepare the bicycle for winter usage first.

Off-road riding subjects the joints in the arms to severe strain. Take a break from riding every 30 to 90 minutes, depending on the condition of the roads.



## Operation

---

### 7.1 Before each ride

---



#### Crash caused by difficult-to-spot damage

---

If the bicycle topples over or you have a fall or an accident, there may be difficult-to-spot damage to components such as the brake system, quick releases or *frame*. This may cause you to fall from the bicycle and injure yourself.

- ▶ Take the bicycle out of service and have a specialist dealer carry out an inspection.
- 



#### Crash caused by material fatigue

---

Intensive use can cause material fatigue. A component may suddenly fail in case of material fatigue. This may cause you to fall from the bicycle and injure yourself.

- ▶ Remove the bicycle from service immediately in case of any signs of material fatigue. Have the specialist dealer check the state.
- ▶ Have the specialist dealer carry out a basic inspection regularly. During the inspection, the specialist dealer inspects the bicycle for any signs of material fatigue on the frame, fork, suspension element mountings (if there are any) and components made of composite materials.

Carbon becomes brittle when exposed to heat radiation such as heating. This can cause the carbon part to break and result in a crash with injuries.

- ▶ Never expose carbon parts to strong heat sources.
-

## 7.2

### Check list before each ride

- ▶ Check the bicycle before each ride.
- ⇒ Do not use the bicycle if there are any anomalies.

<input type="checkbox"/>	Check that the bicycle is complete.
<input type="checkbox"/>	Check that the lighting, reflector and brake, for instance, are sufficiently clean.
<input type="checkbox"/>	You must check that the mudguards, the pannier rack and the chain guard are securely installed.
<input type="checkbox"/>	Check that the front and rear wheels run true. This is particularly important if the bicycle has been transported or secured with a lock.
<input type="checkbox"/>	Check the valves and the tyre pressure. Adjust as necessary before each ride.
<input type="checkbox"/>	If the bicycle has a hydraulic rim brake, check whether the locking levers are fully closed in their final positions.
<input type="checkbox"/>	Check the front and rear wheel brakes to make sure that they are working properly. To do so, operate the brake levers while stationary in order to check whether resistance is generated in the usual brake lever position. The brake must not lose any brake fluid.
<input type="checkbox"/>	Check that the driving light is working.
<input type="checkbox"/>	Check for unusual noises, vibrations, smells, staining, deformation, cracks, scores, abrasion and wear. This indicates material fatigue.
<input type="checkbox"/>	Inspect suspension system for cracks, dents, bumps, parts or leaking oil. Look at concealed sections on the bicycle's lower surfaces.
<input type="checkbox"/>	Use body weight to compress suspension system. Adjust to the optimum "SAG" value if suspension is too soft.
<input type="checkbox"/>	If quick releases are used check them to make sure that they are fully closed in their end position. If quick release axle systems are used, make sure that all attachment screws are tightened to the correct torque.
<input type="checkbox"/>	Be alert to any unusual operating sensations when braking, pedalling or steering.

## Operation

---

### 7.3 Using the kickstand

---



#### CAUTION

#### Crash caused by a lowered kickstand

The kickstand does not fold up automatically. There is a risk of crashing if riding with the kickstand lowered.

- ▶ Raise the kickstand completely before the ride.

#### NOTICE

The heavy weight of the bicycle may cause the kickstand to sink into soft ground and the bicycle may topple and crash over.

- ▶ The bicycle must be parked on firm, level ground only.
- ▶ It is particularly important to check that the bicycle is stable if it is equipped with accessories or loaded with luggage.

#### Raising the kickstand

- ▶ Before the ride, raise the kickstand completely with your foot.

#### Parking the bicycle

- ▶ Before parking, lower the kickstand completely with your foot.
- ▶ Park the bicycle carefully and check that it is stable.

## 7.4 Using the pannier rack



### Crash caused by loaded pannier rack

The riding performance of the bicycle changes with a loaded *pannier rack*, in particular when steering and braking. This can lead to a loss of control. This may cause you to fall from the bicycle and injure yourself.

- ▶ You should practice how to use a loaded *pannier rack* safely and reliably before using the bicycle in public spaces.



### Crash caused by unsecured luggage

Loose or unsecured objects on the *pannier rack*, e.g. belts, may become caught in the rear wheel. This may cause you to fall from the bicycle and injure yourself.

Objects which are fastened to the pannier rack may cover the bicycle's *reflectors* and the *driving light*. The bicycle may be overseen on public roads. This may cause you to fall from the bicycle and injure yourself.

- ▶ Secure any objects which are attached to the *pannier rack* sufficiently.
- ▶ Objects fastened to the *pannier rack* must never cover the *reflectors*, the *headlight* or the *rear light*.



### Crushing the fingers in the spring flap

The spring flap on the *pannier rack* operates with a high clamping force. There is a risk of crushing the fingers.

- ▶ Never allow the spring flap to snap shut in an uncontrolled manner.
- ▶ Be careful where you position your fingers when closing the spring flap.

## Operation

---

### NOTICE

The maximum load bearing capacity is indicated on the *pannier rack*.

- ▶ Never exceed the permitted *total weight* when packing the bicycle.
  - ▶ Never exceed the maximum load bearing capacity of the *pannier rack*.
  - ▶ Never modify the *pannier rack*.
- 
- ▶ Distribute the luggage as evenly as possible on the left and right-hand side of the bicycle.
  - ▶ We recommend the use of panniers and luggage baskets.



## 7.5 Rechargeable battery

### **WARNING**

#### **Fire and explosion due to defective battery**

The safety electronics on a damaged or faulty battery may fail. The residual voltage can cause a short circuit. The battery may self-ignite and explode.

- ▶ Remove batteries with external damage from service immediately and never charge them.
- ▶ If the battery becomes deformed or begins to smoke, keep at a safe distance, disconnect the power supply at the socket, and notify the fire service immediately.
- ▶ Never extinguish a damaged battery with water or allow it to come into contact with water.
- ▶ If a battery is dropped or struck but shows no signs of external damage, remove it from service and observe it for at least 24 hours.
- ▶ Faulty batteries are hazardous goods. Dispose of faulty batteries properly and as quickly as possible.
- ▶ Store in a dry place until disposal. Never store in the vicinity of flammable substances.
- ▶ Never open or repair the battery.

### **CAUTION**

#### **Chemical burns to the skin and eyes caused by faulty battery**

Liquids and vapours may leak from a damaged or faulty battery. They can irritate the airways and cause burns.

- ▶ Avoid contact with leaked liquids.
- ▶ Immediately consult a doctor in case of contact with the eyes or any discomfort.
- ▶ In case of contact with the skin, rinse off immediately with water.
- ▶ Ventilate the room well.

## Operation

---



### **Risk of fire and explosion due to high temperatures**

Excessively high temperatures will damage the battery. The battery may self-ignite and explode.

- ▶ Never expose the battery to sustained direct sunlight.



### **Fire and explosion caused by short circuit**

Small metal objects may jumper the electrical connections of the battery. The battery may self-ignite and explode.

- ▶ Keep paper clips, screws, coins, keys and other small parts away and do not insert them into the battery.



### **Fire and explosion caused by penetration by water**

The battery is only protected from simple spray water. Penetration by water can cause a short circuit. The battery may self-ignite and explode.

- ▶ Never immerse the battery in water.
- ▶ If there is reason to believe that water may have entered into the battery, the battery must be removed from service.

### **NOTICE**

If a key is left inserted when transporting the bicycle or when riding, it may break off or the lock may open accidentally.

- ▶ Remove the key from the battery lock immediately after use.
- ▶ We recommend that you attach the key to a key ring.

- ✓ Before the battery is removed or inserted, switch off the battery and the drive system.

### 7.5.1

#### Removing the battery

- ▶ Open the battery lock with the key.
- ⇒ The battery is released and falls into the retainer guard.
- ▶ Hold the battery in your hand from below. Use the other hand to push on the retainer guard from above.
- ⇒ The battery is released and falls into the hand.
- ▶ Remove the battery from the frame.
- ▶ Remove the key from the lock.

### 7.5.2

#### Inserting the battery

- ▶ Place the battery with the contacts first into the lower mount.
- ▶ Flip the battery up so that it is held by the retainer guard.
- ▶ Push the battery upwards so that it audibly clicks into place.
- ▶ Check the battery to make sure it is firmly in place.
- ▶ Lock the battery with the key. Otherwise the battery may fall out of the mount when you open the lock.
- ▶ Remove the key from the lock.

## Operation

---

### 7.5.3 Charging the battery

---



#### Fire caused by overheated charger

---

The charger heats up when charging the battery. In case of insufficient cooling, this can result in fire or burns to the hands.

- ▶ Never use the charger on a highly flammable surface (e.g. paper, carpet etc.).
  - ▶ Never cover the charger during the charging process.
- 



#### Electric shock caused by penetration by water

---

If water penetrates into the charger, there is a risk of electric shock.

- ▶ Never charge the battery outdoors.
- 



#### Electric shock in case of damage

---

Damaged chargers, cables and plug connectors increase the risk of electric shock.

- ▶ Check the charger, cable and plug connector before each use. Never use a damaged charger.
- 



#### Risk of fire and explosion caused by damaged battery

---

The safety electronics on a damaged or faulty battery may fail. The residual voltage can cause a short circuit. The battery may self-ignite and explode.

- ▶ If the battery becomes deformed or begins to smoke, keep at a safe distance, disconnect the power supply at the socket, and notify the fire service immediately.
  - ▶ Never extinguish a damaged battery with water or allow it to come into contact with water.
- 



If an error occurs during the charging process, a system message is displayed. Remove the charger and battery from operation immediately and follow the instructions.

---

---

## Operation

- ▶ The ambient temperature during the charging process must be within the range from 10 °C to 30 °C.

---

<b>Charging temperature</b>	10 °C–30 °C
-----------------------------	-------------

---

- ✓ The battery can remain on the bicycle or be removed for charging.
- ✓ Interrupting the charging process does not damage the battery.
- ▶ Remove the rubber cover from the battery.
- ▶ Connect the mains plug of the charger to a normal domestic, grounded socket.

---

<b>Connection data</b>	230 V, 50 Hz
------------------------	--------------

---

- ▶ Connect the charging cable to the battery's charging port.
- ⇒ The charging process starts automatically.
- ⇒ During the charging process the operating and charge status indicator indicates the charge status. When the drive system is switched on, the *display* shows the charging process.
- ⇒ The charging process is complete when the LEDs of the operating and charge status indicator go out.

### 7.5.4

#### Waking the battery

- ✓ When not used for a longer period, the battery switches to sleep mode for self-protection. The LEDs of the operating and charge status indicator do not light up.
- ▶ Press the *On-Off button (battery)*.
- ▶ The battery's operating and charge status indicator indicates the charge status.

## Operation

---

### 7.6 Electric drive system

#### 7.6.1 Switching on the drive system

---



##### Crash caused by lack of readiness for braking

When it is switched on, the drive system can be activated by the application of force on the pedals. There is a risk of a crash if the drive is activated unintentionally, and the brake is not reached.

- ▶ Never start the electric drive system, or switch it off immediately, if the brake cannot be reached safely and reliably.
- 
- ✓ A sufficiently charged battery has been inserted on the bicycle.
  - ✓ The battery is firmly positioned. The key has been removed.
- ▶ Press the **On-Off button (battery)**.
  - ⇒ If the drive system is switched on, the drive is activated as soon as the pedals are moved with sufficient force.

#### 7.6.2 Activating the standby mode

If the bicycle is not moved, the display unit and motor will switch to standby mode. This can also be activated manually. As soon as you move the bicycle again, the display and motor are activated again and the electric drive system is once again available. After two hours in standby, the battery will switch to deep sleep mode.

If you wish to switch your bicycle off for a short time, you can switch it to standby as follows:

- ▶ Briefly press the **On-Off button (operating element)**.
- ⇒ The battery remains in standby mode for 2 hours.

### 7.6.3

#### Switching off the drive system

The system switches off automatically ten minutes after the last command. The following options are available to manually switch off the drive system.

- ▶ Press the **On-Off button (operating element)** for >3 sec.

or

- ▶ Press the **On-Off button (battery)** for >3 sec.

⇒ The display, operating element, motor and battery will be switched off completely.

## Operation

### 7.7 Control panel with display

#### 7.7.1 Removing and attaching the display

##### NOTICE

If the rider is not present, the *display* can be used without authorisation, e.g. it may be stolen, the system settings may be changed or journey information may be read.

- ▶ Remove the *display* when the bicycle is parked.

##### Attaching the display

- ▶ Place the *display* tilted to the left on the *mount*.
- ▶ Turn the *display* 45° clockwise.
- ▶ Connect the display to the motor via the intermediate cable.

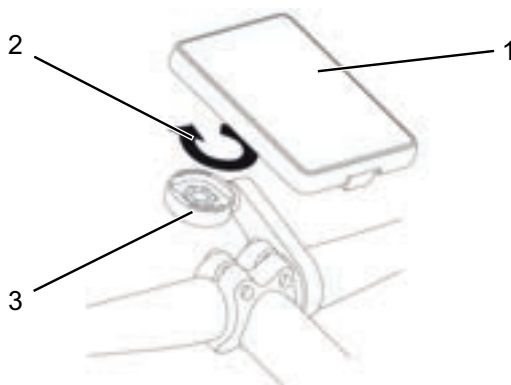

Figure 49: Attaching the display



### Removing the display

- ▶ Disconnect the display from the intermediate cable.
- ▶ Turn the *display* 45° anticlockwise.
- ▶ Remove the *display* from above.

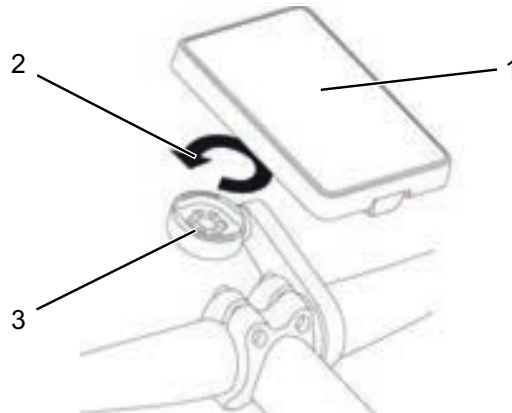

Figure 50:

#### Removing the display

- 1 Display
- 2 Rotation direction of the display
- 3 Mount

### 7.7.2

#### Using the driving light

- ✓ To switch on the *driving light*, the drive system has to be switched on already.
- ▶ Press the **headlight button** briefly.
- ⇒ The *driving light* is switched on, and the *driving light symbol* is displayed.
- ▶ Press the **headlight button** briefly again.
- ⇒ The *running light* is switched off, and the *driving light symbol* is not displayed.

## Operation

---

### 7.7.3 Using the push assist system

---



#### CAUTION

#### Fall caused by strong acceleration

---

If the pedals are pressed with the push assist activated, the bicycle accelerates rapidly. This may cause you to fall from the bicycle and injure yourself.

- ▶ Never mount the bicycle with the push assist activated.

#### NOTICE

The pedals turn when using the push assist due to the system design.

- ▶ You must steer the bicycle securely with both hands when using push assist.
- ▶ Allow for enough freedom of movement for the pedals.
- ▶ Never use a push assist for slow riding.

---

The push assist helps the rider to push the bicycle. The maximum speed can be 6 km/h here.

- ▶ Press and hold the **push assist button** for longer than three seconds.
- ⇒ The push assist is activated. The *push assist symbol* is displayed.
- ▶ Release the **push assist button** to shut off the push assist.

### 7.7.4 Selecting the level of assistance

- ▶ Press the **plus button**.
- ⇒ The level of assistance is increased.
- ▶ Press the **minus button**.
- ⇒ The level of assistance is reduced.

### 7.7.5 Switching journey information

The displayed *journey information* can be changed and partially reset.

- ▶ Press the **info button** repeatedly until the *journey information* is displayed.

### 7.7.6 Using the USB port

#### NOTICE

Any moisture which enters through the USB port may trigger a short circuit in the *display*.

- ▶ Regularly check the position of the rubber cover on the USB port and adjust it as necessary.

The USB port can be used to operate external devices which can be connected using a standard micro A/ micro B USB 2.0 cable.

- ✓ The display has been inserted correctly into the mount.
- ▶ Open the protective flap on the USB port.
- ▶ Using a suitable USB cable, connect the USB interface and the desired end device.
- ⇒ The display "CHArG" will appear briefly on the display.
- ▶ Replace the protective flap after using the USB port.

## Operation

### 7.7.7

### Changing the system information

The following system settings can be changed:

Screen display	Function
RESET TRIP	Set trip time, calories burned, distance and average speed to 0
RESET ALL	Set all values incl. total distance and total trip time to 0
DATE	DD/MM/YY
TIME FORMAT	24/12
TIME	hh/mm
LANGUAGE	German/English
METRIC/IMPERIAL	km/mi

Table 29:

#### Changeable system settings

- ▶ Press and hold the **headlight button** for three seconds.
  - ▶ Press the **info button** repeatedly until the *journey information* is displayed.
  - ▶ Change values by pressing the **minus** and **plus buttons**.
  - ▶ When the values are correct, press the **info button** briefly.
  - ▶ Press and hold the **headlight button** for three seconds.
- ⇒ The *journey information* is displayed again.

## 7.8 Gear shift

The selection of the appropriate gear is a prerequisite for a physically comfortable ride and making sure that the electric drive system functions properly. The ideal pedalling frequency is between 70 and 80 revolutions per minute.

- It is advisable to stop pedalling briefly when changing gears. This makes it easier to switch gears and reduces wear on the drivetrain.

### 7.8.1 Selecting gears

The speed and range can be increased while applying the same force if you select the right gear. A gear recommendation is shown on the display to help you select.

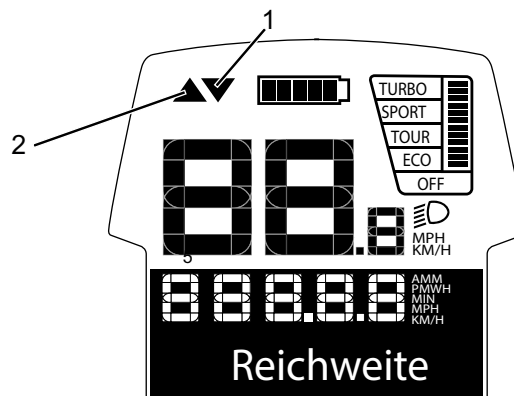
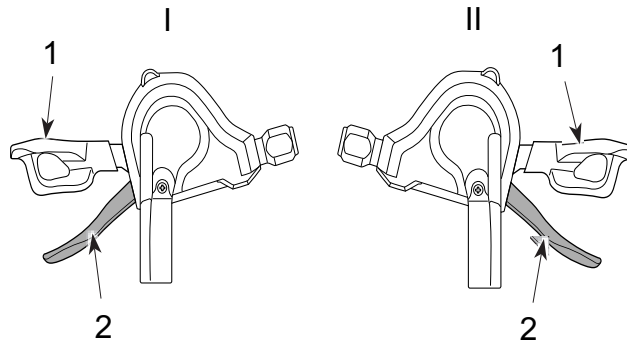

**Figure 51:** Display with high (2) and low (1) gear recommendation

- If the gear recommendation is shown high, you should shift to a higher gear with a lower pedalling frequency.
- If the gear recommendation is shown low, you should shift to a lower gear with a higher pedalling frequency.

## Operation

### 7.8.2 Using the derailleur gears *Alternative*



**Figure 52:** Down shifter (1) and up shifter (2) on the left (I) and right (II) shift

- ▶ Select the appropriate gear with the *shifter*.
- ⇒ The gear shift switches the gear.
- ⇒ The shifter returns to its original position.
- ▶ Clean the rear derailleur if the gear change blocks.

### 7.8.3 Using a hub gear *Alternative*



#### CAUTION

#### Crash caused by incorrect use

If the rider applies too much pressure on the pedals during a gear change and activates the shifter or changes several gears at a time, their feet may slip from the pedals. The bicycle may flip over or fall, which may cause injuries.

Switching down several gears to a low gear may cause the twist grip outer sleeve to suddenly come off. This will not have an adverse effect on the twist grip's correct functioning since the outer guide returns to its original position after the gear change is complete.

- ▶ Apply little pressure on the pedals while changing gears.
- ▶ Never change more than one gear at a time.

#### NOTICE

The interior hub is not completely waterproof. If water gets into the hub, it may rust and the gear switch function may no longer function as a result.

- ▶ Never use the bicycle in places where water may get into the hub.

#### NOTICE

In rare cases, noises may be heard from the rear derailleur in the hub interior after a gear change. This is normal when gears are changed.

#### NOTICE

Do not detach the hub. If you need to detach it, contact your dealer.

## Operation

---

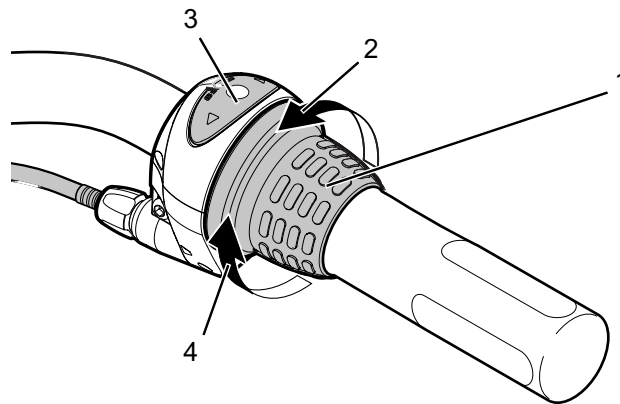

**Figure 53:** Example; Shimano Nexus gear shift: twist grip (1) for the hub gear with its screen (3), the direction of rotation to switch up a gear (2) and the direction of rotation to switch down a gear (4)

- ▶ Turn the twist grip.
- ⇒ The gear shift switches the gear.
- ⇒ The number on the screen display shows the changed gear.



## 7.9

### Brake

**DANGER**

**Hydraulic fluid can be fatal if it is swallowed and penetrates into the respiratory system**

Hydraulic fluid may leak out after an accident or due to material fatigue. Hydraulic fluid can be fatal if swallowed and inhaled.

#### First aid treatment

- ▶ Wear gloves and safety goggles as protective equipment. Keep unprotected persons away.
- ▶ Remove those affected from the danger area to fresh air. Never leave those affected unattended.
- ▶ Ensure sufficient ventilation.
- ▶ Immediately remove clothing items contaminated with hydraulic fluid.
- ▶ Serious slip hazard due to hydraulic fluid leakage.
- ▶ Keep away from naked flames, hot surfaces and sources of ignition.
- ▶ Avoid contact with skin and eyes.
- ▶ Do not inhale vapours or aerosols.

#### After inhalation

- ▶ Take in fresh air; consult doctor if any pain or discomfort.

#### After skin contact

- ▶ Wash affected skin with soap and water and rinse well. Remove contaminated clothing. Consult doctor if any pain or discomfort.

## Operation

---

### After contact with eyes

- ▶ Rinse eyes under flowing water for at least ten minutes with the lids open; also rinse under lids. Consult eye doctor if pain or discomfort continues.

### After ingestion

- ▶ Rinse out mouth with water Never induce vomiting! Risk of aspiration!
- ▶ Place a person lying on their back who is vomiting in a stable recovery position on their side. Seek medical advice immediately.

### Environmental protection measures

- ▶ Never allow hydraulic fluid to flow into the sewage system, surface water or groundwater.
- ▶ Notify the relevant authorities if fluid penetrates the ground or pollutes water bodies or the sewage system.

 **WARNING**

---

### Amputation due to rotating brake disc

The brake disc in disc brakes is so sharp that it can cause serious injuries to fingers if they are inserted into the disc brake openings.

- ▶ Always keep fingers well away from the rotating brake disc.
-

 **WARNING****Crash caused by brake failure**

Oil or lubricant on the brake disc in a disc brake or on the rim of a rim brake can cause the brake to fail completely. This may cause a crash with serious injuries as a consequence.

- ▶ Never allow oil or lubricant to come into contact with the brake disc or brake linings or on the rim of a rim brake.
- ▶ If the brake linings have come into contact with oil or lubricant, contact a dealer or a workshop to have the components cleaned or replaced.

If the brakes are applied continuously for a long time (e.g. while riding downhill for a long time), the fluid in the brake system may heat up. This may create a vapour bubble. This will cause air bubbles or any water contained in the brake system to expand. This may suddenly make the lever travel wider. This may cause a crash with serious injuries.

- ▶ Release the brake regularly when riding downhill for a longer period of time.

 **CAUTION****Crash caused by wet conditions**

The *tyres* may slip on wet roads. In wet conditions you must also expect a longer braking distance. The braking sensation differs from the usual sensation. This can cause loss of control or a crash, which may result in injuries.

- ▶ Ride slowly and brake in good time.

## Operation

---



### Crash caused by incorrect use

Handling the brake improperly can lead to loss of control or crashes, which may result in injuries.

- ▶ Shift your body weight back and down as far as possible.
- ▶ Practise braking and emergency braking before the bicycle is used in public spaces.
- ▶ Never use the bicycle if you can feel no resistance when pulling on the brake handle. Consult a specialist dealer.



### Crash after cleaning or storage

The brake system is not designed for use on a bicycle which is placed on its side or turned upside down. The brake may not function correctly as a result. This can cause a crash, which may result in injuries.

- ▶ If the bicycle is placed on its side or turned upside down, apply the brake a couple of times before setting off to ensure that it functions normally.
- ▶ Never use the bicycle if it no longer brakes as normal. Consult a specialist dealer.



### Burns caused by heated brake

The brakes may become very hot during operation. There is a risk of burns or fire in case of contact.

- ▶ Never touch the components of the brake directly after the ride.

---

 Operation

The drive force of the motor is shut off during the ride as soon as the rider no longer pedals. The drive system does not switch off when braking.

- ▶ In order to achieve optimum braking results, do not pedal while braking.

### 7.9.1 Using the brake lever

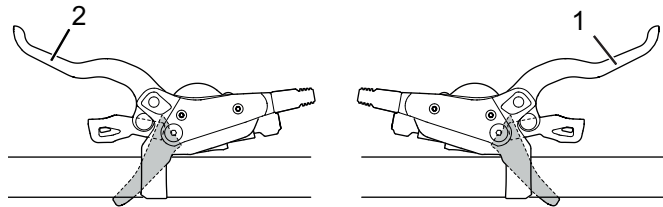

Figure 54:

Front (2) and rear (1) brake lever; Shimano brake used as an example

- ▶ Pull the left *brake lever for the front wheel brake* and the right lever for the rear wheel brake until the desired speed is reached.

### 7.9.2 Using the back-pedal brake *Alternative*

- ✓ The best braking effect is achieved if the pedals are in the 3 o'clock and 9 o'clock position when braking. To bridge the free travel between the riding movement and the braking movement, it is recommendable to pedal a little beyond the 3 o'clock and 9 o'clock position before you pedal in the opposite direction to the *direction of travel* and start braking.
- ▶ Pedal in the opposite direction to the *direction of travel* until the desired speed has been reached.

## Operation

### 7.10 Suspension and damping

#### 7.10.1 Adjusting the compression of the Suntour fork *Alternative*

The compression adjuster makes it possible to make quick adjustments to the suspension behaviour of the fork to suit changes in terrain. It is intended for adjustments made during the ride.



**Figure 55:** Suntour compression adjuster with the OPEN (1) and LOCK (2) positions

- Compression damping is lowest in the OPEN position, making the fork feel softer. Use the LOCK position if you want the fork to feel stiffer and you are riding on soft ground. The lever positions between the OPEN and LOCK positions enable fine adjustment of compression damping.

We recommend setting the lever of the compression adjuster to the OPEN position first.

## 7.10.2

### Adjusting the compression of the Fox fork *Alternative*

The compression adjuster makes it possible to make quick adjustments to the suspension behaviour of the fork to suit changes in terrain. It is intended for adjustments made during the ride.

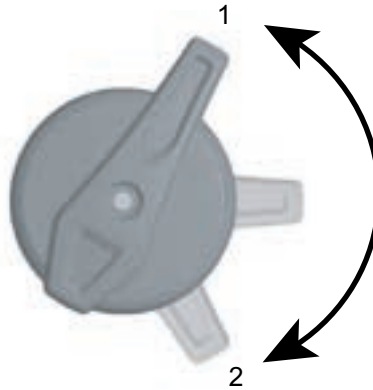

Figure 56:

**FOX compression adjuster with the OPEN (1) and HARD (2) positions**

- Compression damping is lowest in the OPEN position, making the fork feel softer. Use the HARD position if you want the fork to feel stiffer and you are riding on soft ground. The lever positions between the OPEN and HARD positions enable fine adjustment of compression damping.

We recommend setting the lever of the compression adjuster to the OPEN mode position first.

## Operation

### 7.10.3 Adjusting the compression of the Fox fork *Alternative*

The compression adjuster makes it possible to make quick adjustments to the suspension behaviour of the damper to suit changes in terrain. It is intended for adjustments made during the ride.



**Figure 57:** FOX compression adjuster on the rear frame damper with the OPEN (1), MEDIUM (2) and HARD (3) positions

- Use the OPEN position for rough descents, the MEDIUM position for uneven terrain and the HARD position for efficient climbing. First set the compression adjuster to the OPEN position.



**Figure 58:** Fine adjustment of the OPEN position is made using the adjuster (4)



## Operation

The FOX rear frame damper features fine adjustment for the OPEN position.

- ✓ We recommend that fine adjustments be made when the compression adjuster is in the MEDIUM or HARD position.
- ▶ Pull out the adjuster.
- ▶ Turn the adjuster to position 1, 2 or 3. Setting 1 is for the softest riding performance, whereas 3 is for the hardest.
- ▶ Press the adjuster in to lock in the setting.

## Maintenance

# 8 Maintenance

### Cleaning check list

<input type="checkbox"/>	Clean pedals	after each ride
<input type="checkbox"/>	Clean suspension fork and, if necessary, rear frame damper	after each ride
<input type="checkbox"/>	Clean battery	once a month
<input type="checkbox"/>	Chain (mainly tarmacked road)	every 250–300 km
<input type="checkbox"/>	Basic cleaning and preservation of all components	at least every six months
<input type="checkbox"/>	Clean the charger	at least every six months
<input type="checkbox"/>	Clean and lubricate height-adjustable seat post	every six months

### Maintenance check list

<input type="checkbox"/>	Check USB rubber cover position	before each ride
<input type="checkbox"/>	Check for tyre wear	once a week
<input type="checkbox"/>	Check for rim wear	once a week
<input type="checkbox"/>	Check the tyre pressure	once a week
<input type="checkbox"/>	Check brakes for wear	once a month
<input type="checkbox"/>	Check electrical cables and Bowden cables for damage and ensure they are fully functional	once a month
<input type="checkbox"/>	Check the chain tension	once a month
<input type="checkbox"/>	Check the tension of the spokes	every three months
<input type="checkbox"/>	Check the gear shift setting	every three months
<input type="checkbox"/>	Check suspension fork and, if necessary, rear frame damper for wear and ensure they are fully functional	every three months
<input type="checkbox"/>	Check for wear on brake discs	at least every six months

## Maintenance

### Service check list

<input type="checkbox"/>	Functional check on the suspension fork	every 50 hours
<input type="checkbox"/>	Suspension fork maintenance and dismantling	every 100 hours or at least once a year
<input type="checkbox"/>	Complete maintenance of the rear frame damper	every 125 hours
<input type="checkbox"/>	Inspection by the specialist dealer	every six months
<input type="checkbox"/>	Inspection of the drive unit	15,000 km

## Maintenance

---

### 8.1 Cleaning and servicing

---



#### **Crash and falling caused by unintentional activation**

There is a risk of injury if the drive system is activated unintentionally.

- ▶ Remove before cleaning.
- 

The following servicing measures must be performed regularly. Servicing can be performed by the operator and rider. In case of any doubt, consult the specialist dealer.

#### 8.1.1 After each ride

##### 8.1.1.1 Cleaning the suspension fork

- ▶ Remove dirt and deposits on the stanchions and deflector seals with a damp cloth.
- ▶ Check the stanchions for dents, scratches, staining or leaking oil.
- ▶ Check the air pressure.
- ▶ Lubricate the dust seals and stanchions.

##### 8.1.1.2 Cleaning the rear frame damper

- ▶ Remove dirt and deposits from the damper body with a damp cloth.
- ▶ Check rear frame damper for dents, scratches, staining or leaking oil.

##### 8.1.1.3 Cleaning the pedals

- ▶ Clean with a brush and soapy water after riding through dirt or rain.
- ⇒ Service the pedals after cleaning.

## 8.1.2 Basic cleaning



### CAUTION

#### Crash caused by brake failure

The braking effect may be unusually poor temporarily after cleaning, servicing or repairing the bicycle. This may cause you to fall from the bicycle and injure yourself.

- ▶ Never apply care products or oil to the brake discs or brake linings, or the braking surfaces on the rims.
- ▶ After cleaning, servicing or repair, carry out a few test brake applications.

### NOTICE

Water may enter into the inside of the bearings if you use a steam jet. This dilutes the lubricant inside, the friction increases and, as a result, the bearings are permanently damaged in the long term.

- ▶ Never clean the bicycle with a steam jet.

### NOTICE

Greased parts, such as the seat post, the handlebars or the stem, may no longer be safely and reliably clamped.

- ▶ Never apply grease or oil to clamping sections.
- ✓ Remove battery and display before basic cleaning.

## Maintenance

---

### 8.1.2.1

#### Cleaning the frame

- ▶ Soak dirt stains on the frame with dish-washing detergent if the dirt is thick and ingrained.
- ▶ After leaving it to soak for a time, remove the dirt and mud with a sponge, brush and toothbrush.
- ▶ Use a watering can or your hand to rinse the frame to finish off.
- ▶ Service the frame after cleaning.

### 8.1.2.2

#### Cleaning the stem

- ▶ Clean stem with a cloth and washing water.
- ▶ Service the stem after cleaning.

### 8.1.2.3

#### Cleaning the rear frame damper

- ▶ Clean rear frame damper with a cloth and washing water.

### 8.1.2.4

#### Cleaning the wheel



---

#### Crash caused by braking hard on rims

A rim can break and block the wheel if you brake hard. It may cause a crash with serious injuries.

- ▶ Check rim wear on a regular basis.

---

- ▶ Check the tyres, rims, spokes and spoke nipples for any damage when cleaning the wheel.
- ▶ Use a sponge and a brush to clean the hub and spokes from the inside to the outside.
- ▶ Clean the rim with a sponge.

**8.1.2.5****Cleaning the drive elements**

- ▶ Spray the cassette, the chain wheels and the front derailleur with a degreasing agent.
- ▶ Clean coarse dirt with a brush after soaking for a short time.
- ▶ Wash down all parts with dish-washing detergent and a toothbrush.
- ▶ Service the drive elements after cleaning.

**8.1.2.6****Cleaning the chain****NOTICE**

- ▶ Never use aggressive (acid-based) cleaners, rust removers or degreasers when cleaning the chain.
- ▶ Do not use chain cleaning devices or chain cleaning baths.
- ▶ Slightly dampen a brush with dish-washing liquid. Brush both sides of the chain.
- ▶ Dampen a cloth with dish-washing liquid. Place the cloth on the chain.
- ▶ Hold with slight pressure while slowly turning the rear wheel, so the chain passes through the cloth.
- ▶ If the chain is still dirty afterwards, clean it with WD40.
- ▶ Service the chain after cleaning.

## Maintenance

---

### 8.1.2.7

#### Cleaning battery

---



#### CAUTION

#### Fire and explosion caused by penetration by water

The battery is only protected from simple spray water. Penetration by water can cause a short circuit. The battery may self-ignite and explode.

- ▶ Never clean the battery with a high-pressure water device, water jet or compressed air.
  - ▶ Never immerse the battery in water.
  - ▶ Never use cleaning agents.
  - ▶ Remove the battery from the bicycle before cleaning.
- 
- ▶ Clean the battery electrical connections with a dry cloth or brush only.
  - ▶ Wipe off the decorative sides with a damp cloth.

### 8.1.2.8

#### Cleaning the display

---

#### NOTICE

If water enters into the display, it will be permanently damaged.

- ▶ Never immerse the display in water.
  - ▶ Never clean with a high-pressure water device, water jet or compressed air.
  - ▶ Never use cleaning agents.
  - ▶ Remove the display from the bicycle before cleaning.
- 
- ▶ Carefully clean the display with a damp, soft cloth.



### 8.1.2.9 Cleaning the drive unit



#### CAUTION

#### Burns from hot drive

The drive cooler can become extremely hot during use. Contact may cause burns.

- ▶ Leave the drive unit to cool before cleaning.



#### NOTICE

If water enters into the drive unit, the unit will be permanently damaged.

- ▶ Never immerse the drive unit in water.
  - ▶ Never clean with a high-pressure water device, water jet or compressed air.
  - ▶ Never use cleaning agents.
  - ▶ Never open.
- 
- ▶ Carefully clean the drive unit with a damp, soft cloth.

### 8.1.2.10 Cleaning the brake



#### WARNING

#### Brake failure due to water penetration

The brake seals are unable to withstand high pressures. Damaged brakes can fail and cause an accident with injury.

- ▶ Never clean the bicycle with a high-pressure water device or compressed air.
  - ▶ Take great care when using a hosepipe. Never point the water jet directly at the seal section.
- 
- ▶ Clean brake and brake discs with a brush, water and dish-washing detergent.
  - ▶ Clean brake discs thoroughly with brake cleaner or spirit.

## Maintenance

---

### 8.1.3

### Servicing

#### 8.1.3.1

#### Servicing the frame

- ▶ Dry frame after cleaning
- ▶ Spray with care oil Clean off the care oil again after a short time.

#### 8.1.3.2

#### Servicing the stem

- ▶ Apply silicone or Teflon oil to the stem shaft tube and the quick release lever pivot point.
- ▶ If you have speedlifter Twist, also apply oil to the unlocking bolt using the groove in the speedlifter body.
- ▶ Apply a little acid-free lubricant grease between the stem quick release lever and the sliding piece to reduce the quick release lever operating force.

#### 8.1.3.3

#### Servicing the fork

- ▶ Treat the dust seals with fork oil

#### 8.1.3.4

#### Servicing the drive elements

- ▶ Spray the cassette, the chain wheels and the front derailleur with a degreasing agent.
- ▶ Clean coarse dirt with a brush after soaking for a short time.
- ▶ Wash down all parts with dish-washing detergent and a toothbrush.

#### 8.1.3.5

#### Servicing the pedal

- ▶ Treat with spray oil after cleaning.



### 8.1.3.6

#### Servicing the chain

- ▶ Grease the chain thoroughly with chain oil after cleaning.

### 8.1.3.7

#### Servicing the drive elements

- ▶ Service front and rear derailleur articulated shafts and jockey wheels with Teflon spray.

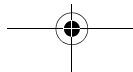
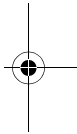
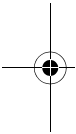

## Maintenance

---

### 8.2 Maintenance

---



#### CAUTION

#### Crash and falling caused by unintentional activation

There is a risk of injury if the drive system is activated unintentionally.

- ▶ Remove the battery before maintenance.

The following maintenance measures must be carried out regularly [▷ *Check list, page 120*]. They can be carried out by the operator and rider. In case of any doubt, consult the specialist dealer.

#### 8.2.1 Wheel

---



#### WARNING

#### Crash caused by braking hard on rims

A rim can break and block the wheel if you brake hard. It may cause a crash with serious injuries.

- ▶ Check rim wear on a regular basis.



#### NOTICE

If the pressure is too low in the tyre, the tyre does not achieve its load bearing capacity. The tyre is not stable and may come off the rim.

If the pressure in the tyre is too high, the tyre may burst.

- ▶ Check the tyre pressure against the specifications [▷ *Data sheet, page 1*]
- ▶ *Adjust the tyre pressure as necessary.*
- ▶ Check the *tyre wear*.
- ▶ Check the *tyre pressure*.
- ▶ Check the *rims* for wear.
- The rims of a rim brake with invisible wear indicator are worn as soon as the wear indicator becomes visible in the area of the rim joint.

- The rims with visible wear indicator are worn as soon as the black, all-round groove on the pad friction surface is no longer visible. We recommend that you also replace the *rims* with every second brake lining replacement.
- ▶ Check the tension of the spokes.

### 8.2.2 Brake system



#### Crash caused by brake failure

Worn brake discs and brake linings, as well as a lack of hydraulic fluid in the brake cable, reduce the braking power. This may cause you to fall from the bicycle and injure yourself.

- ▶ Check the brake disc, brake linings and the hydraulic brake system on a regular basis and replace if necessary.
- 
- ▶ Replace the brake linings on the disc brake when the pad thickness has reached 0.5 mm.

### 8.2.3 Electrical cables and brake cables

- ▶ Check all visible electrical cables and cables for damage. If, for example, the sheathing is compressed, the bicycle will need to be removed from service until the cables have been replaced.
- ▶ Check all electrical cables and cables to make sure they are fully functional.

### 8.2.4 Gear shift

- ▶ Check the gear shift and the *shifter* or the *twist grip* setting and adjust it as necessary.

## Maintenance

### 8.2.5

#### Stem

- ▶ The stem and quick release system should be inspected at regular intervals. The specialist dealer should adjust them if necessary.
- ▶ If the hexagon socket head screw is also loosened, the headset backlash also needs to be adjusted. Medium-strength thread locker, such as Loctite blue, then needs to be applied to the loosened screws and the screws tightened as per the instructions.
- ▶ Check for wear and signs of corrosion (maintain with an oily cloth) and for oil leaks.

### 8.2.6

#### Checking the chain and belt tension

#### NOTICE

Excessive chain or belt tension increases wear.

If the chain or belt tension is too low, there is a risk that the *chain* or belt will slip off the *chain wheels*.

- ▶ Check the chain or belt tension once a month.
  - ▶ Check the chain or belt tension in three or four positions, turning the crank a full revolution.
  - ▶ If the *chain* or the belt can be pushed more than 2 cm, you need to have the *chain* or belt tensioned again by the specialist dealer.
  - ▶ If the *chain* or belt can only be pushed up and down less than 1 cm, you will need to slacken the *chain* or belt slightly.
- ⇒ The ideal chain or belt tension has been achieved if the *chain* or the belt can be pushed a maximum of 2 cm in the middle between the pinion and the toothed wheel. The crank must also turn without resistance.



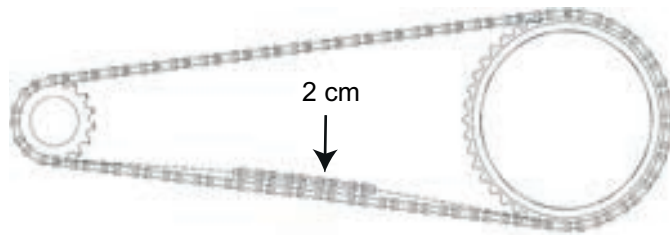

**Figure 59:** Checking the chain and belt tension



- ▶ If a hub gear is featured, the rear wheel must be pushed backwards or forwards to tighten the chain. This should be done by a specialist only.

### 8.2.7

#### USB port

#### NOTICE

Any moisture which enters through the USB port may trigger a short circuit in the *display*.

- ▶ Regularly check the position of the *cover on the USB port* and adjust it as necessary.

### 8.2.8

#### Suspension fork



- ▶ The specialist dealer will check the suspension fork function and the torques of attachment screws and nuts on the lower surfaces (steel: 10 Nm; alloy: 4 Nm). They will check the suspension fork for scratches, dents, cracks, stains, oil leaks or signs of wear or corrosion.

## Maintenance

---

### 8.3

### Service

---



#### CAUTION

#### Crash and falling caused by unintentional activation

There is a risk of injury if the drive system is activated unintentionally.

- ▶ Remove the battery before inspection.
- 



#### CAUTION

#### Crash caused by material fatigue

If the service life of a component has expired, the component may suddenly fail. This may cause you to fall from the bicycle and injure yourself.

- ▶ Have the specialist dealer carry out six-monthly basic cleaning of the bicycle, preferably at the same time as the required servicing work.
- 

#### NOTICE

The motor is maintenance-free and may only be opened by qualified specialist personnel.

- ▶ Never open the motor.
- 

The specialist dealer must perform an inspection at least every six months. This is the only way to ensure that the bicycle remains safe and fully functional.



- ▶ The specialist dealer will inspect the bicycle for any signs of material fatigue during basic cleaning.
- ▶ The specialist dealer will check the software version of the drive system and update it. The electrical connections are checked, cleaned and preservative agent is applied. The electrical cables are inspected for damage.



## Maintenance



- ▶ The specialist dealer will dismantle and clean the entire suspension fork interior and exterior. They will clean and lubricate the dust seals and slide bushings, check the torques and adjust the fork to the rider's preferred position. They will also replace the sliding collar if the clearance is too great (more than 1 mm on the fork bridge).
- ▶ The specialist dealer will fully inspect the interior and exterior of the rear frame damper, overhaul the rear frame damper, replace all air seals of air forks, overhaul the air suspension, change the oil and replace the dust wipers.
- ▶ The further servicing measures correspond to those which are recommended for a bicycle as per EN 4210. Particular attention is paid to the rim and brake wear. The spokes are re-tightened in accordance with the findings.

## Maintenance

---

### 8.4 Adjusting and repairing

---



#### Crash and falling caused by unintentional activation

---

There is a risk of injury if the drive system is activated unintentionally.

- ▶ Remove the battery before inspection.
- 

#### 8.4.1 Use original parts and lubricants only

The individual parts of the bicycle have been selected carefully and to matched to each other.

Only original parts and lubricants must be used for maintenance and repair.

The constantly updated lists of approved accessories and parts are available to specialist dealers.

## 8.4.2 Wheel quick release



**CAUTION**

### Crash caused by unfastened quick release

A faulty or incorrectly installed quick release may become caught in the brake disc and block the wheel. This will cause a crash.

- ▶ Install the front wheel quick release lever on the opposite side to the brake disc.



**CAUTION**

### Crash caused by faulty or incorrectly installed quick release

The brake disc becomes very hot during operation. Parts of the quick release may become damaged as a result. The quick release comes loose. This will result in a crash and injuries.

- ▶ The front wheel quick release lever and the brake disc must be situated on opposite sides.



**CAUTION**

### Crash caused by incorrectly set clamping force

Excessively high clamping force will damage the quick release and cause it to lose its function.

Insufficient clamping force will cause a detrimental transmission of force. The suspension fork or the frame may break. This will result in a crash and injuries.

- ▶ Never fasten a quick release using a tool (e.g. hammer or pliers).
- ▶ Only use the clamping lever with the specified set clamping force.

## Maintenance

### 8.4.2.1

#### Clamping the clamping lever

The clamping lever for the quick release is marked OPEN and CLOSE. If you can read the word OPEN, the quick release is open. If you can read the word CLOSE, the quick release is clamped.

- ▶ Align the clamping lever properly and push it through as far as it will go.
- ⇒ The wheel clamping lever is clamped if the clamping lever can be moved easily from the open final position into the middle and has to be pressed with the fingers or base of the thumb from the middle point onwards.

### 8.4.2.2

#### Clamping version I

- ▶ Hold the open clamping lever. Screw the setting nut tight on the opposite side.
- ▶ Clamp the clamping lever.
- ⇒ The final position of the clamping lever is at a right angle to the fork or frame.

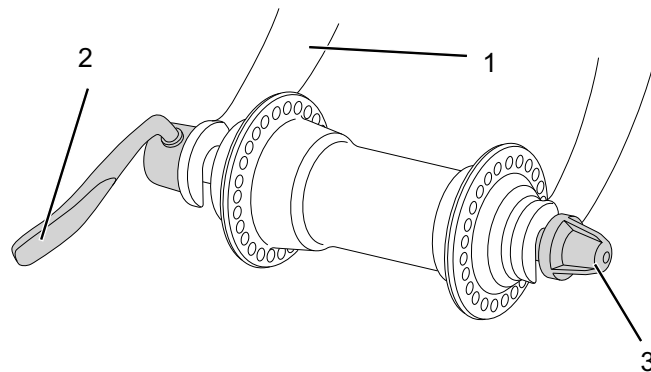

**Figure 60:** Wheel quick release, version I, with clamping lever (2), fork (1) and setting nut (3)

### Checking and setting the clamping force of the quick releases

If the clamping lever cannot be moved into the final position just by pushing it with the hand, or if it is too loose, its clamping force will need to be readjusted.

- ✓ The clamping lever is completely open.
- ▶ Turn the setting nut a little.
- ▶ Clamp the clamping lever.
- ▶ Repeat the steps until the proper angle has been achieved.

#### 8.4.2.3

#### Clamping version II

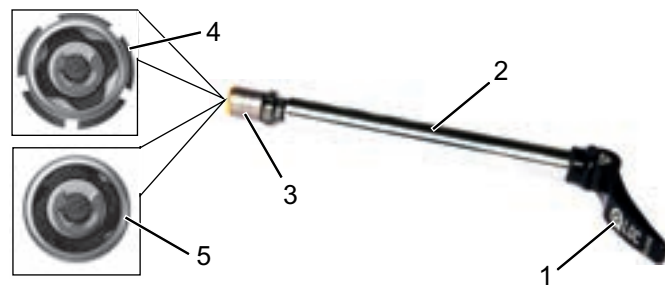

Figure 61:

Quick release, version II, with clamping lever (1), axle (2), setting nut (3), and detailed view of the open (4) and closed (5) flange

- ✓ The clamping lever is completely open.
- ▶ Push the axle into the hub as far as it will go.
- ▶ Align the clamping lever.
- ▶ Close the clamping lever
- ⇒ The final position of the clamping lever is forward, parallel to the fork.

## Maintenance

### 8.4.2.4 Clamping version III

#### NOTICE

If the clamping force is insufficient, have the specialist dealer inspect it.

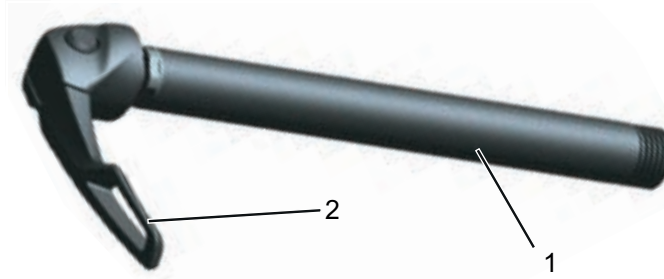

Figure 62: Quick release, version III, with axle (1) and clamping lever (2)

- ▶ Push the axle into the hub as far as it will go with the clamping lever completely open.
- ▶ Screw the quick release on the open clamping lever clockwise into the hub as far as it will go.
- ▶ Screw it out one turn.
- ▶ Use the fingers to screw in the clamping lever in the semi-open position, roughly in the middle between OPEN and CLOSE, until you feel resistance.
- ▶ Clamp the clamping lever.

### 8.4.2.5

#### Clamping version IV

- ▶ Push the axle into the hub as far as it will go with the clamping lever open.
- ▶ Screw the clamping lever clockwise into the correct final position.
- ▶ Clamp the clamping lever.

#### Setting the clamping force

If the clamping force is set too high, the clamping lever cannot be pushed into the closed final position.

- ▶ Turn the twist knob:
  - Turn 1/8 turn anti-clockwise to reduce the clamping force.
  - Turn 1/8 turn clockwise to increase the clamping force.
- ▶ Clamp the clamping lever.
- ▶ If the clamping lever is not yet in the proper final position, repeat the steps until the proper final position has been achieved.

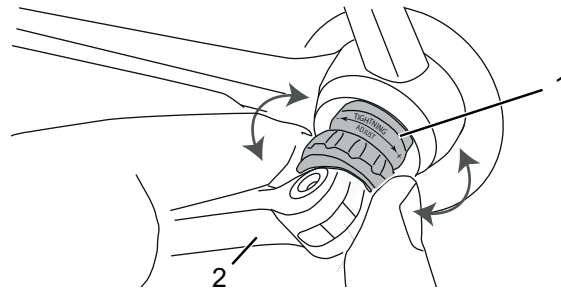

Figure 63:

Wheel quick release, version IV, with twist knob (1) and clamping lever (2)

## Maintenance

### 8.4.2.6

### Clamping version V



#### Crash caused by unfastened quick release

The clamping force of the quick release lever is set once during assembly and is not an indication that the wheel axle is sufficiently fastened. The axle may come loose if the closed quick release is turned. This will result in a crash and injuries.

- ▶ Never adjust or turn a quick release after closing it, e.g. to correct the final position.
- ▶ Push the axle into the hub from the left until it meshes in the thread on the right-hand fork end.



Figure 64:

Quick release, version V, with axle (1) and clamping lever (2)

- ▶ Flip the quick release lever into the recess.

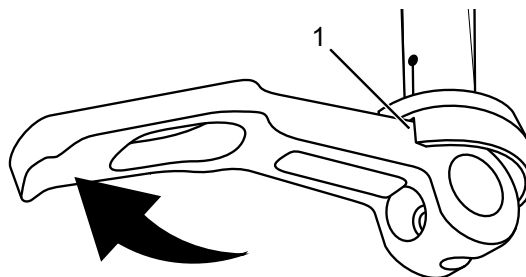

Figure 65:

Flipping the quick release into the recess (1)



- ▶ Turn the axle on the quick release clockwise until the axle is firmly in place.
- ▶ Pull the lever from the recess and clamp it properly.
- ▶ The clamping force of the lever is not an indication of the tightening torque of the axle.

### Setting the clamping force

If the clamping lever cannot be moved into its proper final position by pushing it with the hand, or if it is too loose, its clamping force will need to be readjusted.

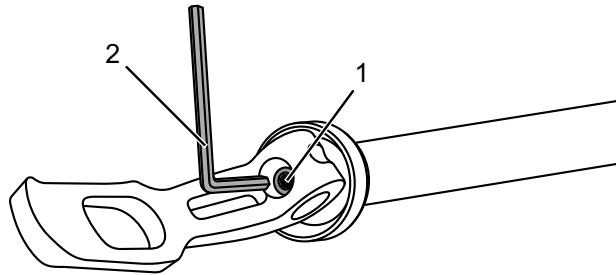

Figure 66:

Setting the clamping force in the middle of the clamping lever (1) with a hexagon socket spanner (2)



- ▶ Open the quick release lever.
- ▶ Connect a 2.5 mm hexagon socket spanner to the middle of the clamping lever.
- ▶ Turn the hexagon socket spanner:
  - turn clockwise to increase the clamping force and
  - anti-clockwise to reduce the clamping force.
- ▶ Clamp the clamping lever.
- ▶ If the clamping lever is not yet in the proper final position, repeat the steps until the proper final position has been achieved.

## Maintenance

### 8.4.3

### Adjusting the tyre pressure

#### 8.4.3.1

#### Dunlop valve

The tyre pressure cannot be measured on the simple Dunlop valve. The tyre pressure is therefore measured in the filling hose when pumping slowly with the bicycle pump.

- ✓ It is recommendable to use a bicycle pump with a pressure gauge. The operating instructions for the bicycle pump must be adhered to.
- ▶ Unscrew and remove the valve cap.
- ▶ Connect the bicycle pump.
- ▶ Pump up the tyre slowly and pay attention to the tyre pressure in the process.
- ⇒ The tyre pressure has been adjusted as per the data [▷ *Data sheet, page 1*].
- ▶ If the tyre pressure is too high, unfasten the union nut, let off air and tighten the union nut again.
- ▶ Remove the bicycle pump.
- ▶ Screw the valve cap tight.
- ✓ Screw the rim nut gently against the rim with the tips of your fingers.



Figure 67:

Dunlop valve with union nut (1) and rim nut (2)

### 8.4.3.2

### Presta valve

- ✓ It is recommendable to use a bicycle pump with a pressure gauge. The operating instructions for the bicycle pump must be adhered to.
- ▶ Unscrew and remove the valve cap.
- ▶ Open the knurled nut around four turns.
- ▶ Carefully apply the bicycle pump so that the valve insert is not bent.
- ▶ Pump up the tyre slowly and pay attention to the tyre pressure in the process.
- ⇒ The tyre pressure has been adjusted as per the data [[Data sheet, page 1](#)].
- ▶ Remove the bicycle pump.
- ▶ Tighten the knurled nut with your fingers.
- ▶ Screw the valve cap tight.
- ▶ Screw the rim nut gently against the rim with the tips of your fingers.



Figure 68:

Presta valve with valve insert (1), knurled nut (2) and rim nut (3)

## Maintenance

---

### 8.4.3.3

#### Schrader valve

- ✓ It is recommendable to use a bicycle pump with a pressure gauge. The operating instructions for the bicycle pump must be adhered to.
- ▶ Unscrew and remove the valve cap.
- ▶ Connect the bicycle pump.
- ▶ Pump up the tyre slowly and pay attention to the tyre pressure in the process.
- ⇒ The tyre pressure has been adjusted as per the data [▷ *Data sheet, page 1*].
- ▶ Remove the bicycle pump.
- ▶ Screw the valve cap tight.
- ▶ Screw the rim nut gently against the rim with the tips of your fingers.



Figure 69:

Schrader valve with rim nut (1)

#### 8.4.4 Adjusting the gear shift

If you cannot select the gears effortlessly, you will need to adjust the setting for the shift cable tension.

- ▶ Carefully pull the *adjusting sleeve* away from the shifter housing, turning it as you do so.
- ▶ Check the gear shift function after each adjustment.



If you are unable to adjust the gear shift in this way, the specialist dealer will need to check the gear shift assembly.

#### 8.4.5 Cable-operated gear shift, single-cable *Alternative*

- ▶ For a smooth gear shift, adjust the adjusting sleeves on the shifter housing.

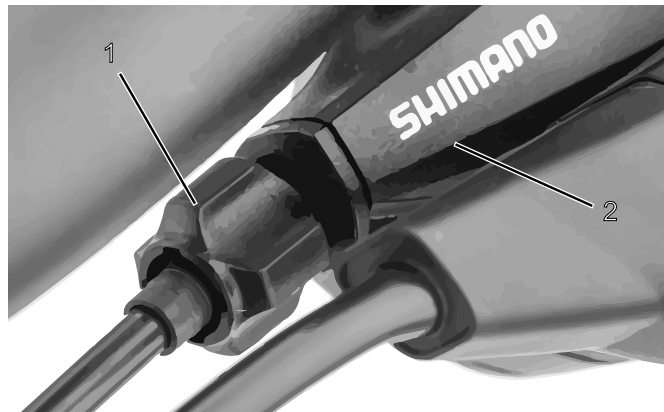

Figure 70: Adjusting sleeve (1) for the single-cable cable-operated gear shift with shifter housing (2), example

## Maintenance

### 8.4.6

#### Cable-operated gear shift, dual-cable *Alternative*

- ▶ For a smooth gear shift, set the adjusting sleeves underneath the chain stay on the frame.
- ▶ The shift cable has around 1 mm play when it is pulled out gently.

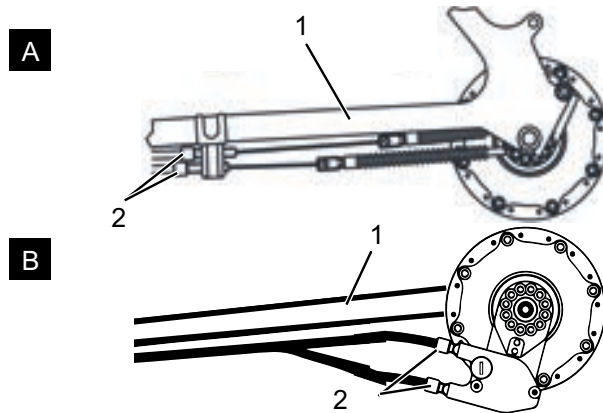

Figure 71:

Adjusting sleeves (2) on two alternative versions (A and B) of a dual-cable cable-operated gear shift on the chain stay (1)

### 8.4.7 Cable-operated twist grip, dual-cable *Alternative*

- ▶ For a smooth gear shift, set the adjusting sleeves on the shifter housing.
- ⇒ There is noticeable play of around 2–5 mm (1/2 gear) when twisting the twist grip.

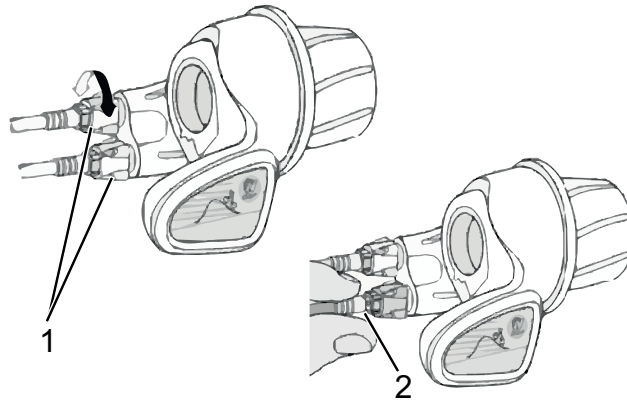

Figure 72: Twist grip with adjusting sleeves (1) and play of the gear shift (2)

## Maintenance

---

### 8.4.8 Offsetting the brake lining wear

#### 8.4.9 Hydraulically operated rim brake *Alternative*

The *setting bolt* on the *brake lever* of the hydraulic rim brake is used to offset the brake lining wear. If the profile of the brake linings has a remaining depth of just 1 mm, the brake linings need to be replaced.

- ▶ In order to reduce the free travel and offset the brake lining wear, screw the *setting bolt* in.
  - ▶ In order to increase the free travel, screw the *setting bolt* out.
- ⇒ With the optimum setting the pressure point, i.e. the point at which the brake takes effect, is reached after 10 mm of free travel.



**Figure 73:** Brake lever (1) of the hydraulically operated rim brake with setting bolt (2)



#### 8.4.10 **Hydraulically operated disc brake** **Alternative**

The brake pad wear on the disc brake does not require readjustment.

#### 8.4.11 **Replacing the lighting**

Alternatively a 3 watt or 1.5 watt lighting system can be installed.

- ▶ Only use components of the respective power class for replacement.

#### 8.4.12 **Setting the headlight**

- ▶ The *headlight* must be set, so that its light beam meets the road 10 m in front of the bicycle.

#### 8.4.13 **Repair by the specialist dealer**



Special knowledge and tools are required for many repairs. Only a specialist dealer may carry out the following repairs, for instance:

- Replacing *tyres* and rims,
- Replacing brake pads and brake linings,
- Replacing and tensioning the *chain*.

## Maintenance

---

### 8.4.14 Replacing the lighting

Alternatively a 3 watt or 1.5 watt lighting system can be installed.

- ▶ Only use components of the respective power class for replacement.

### 8.4.15 Setting the headlight

- ▶ The *headlight* must be set, so that its light beam meets the road 10 m in front of the bicycle.

### 8.4.16 Repair by the specialist dealer



Special knowledge and tools are required for many repairs. Only a specialist dealer may carry out the following repairs, for instance:

- Replacing *tyres* and rims,
- Replacing brake pads and brake linings,
- Replacing and tensioning the *chain*.

## 8.4.17

### First aid for system messages



#### Fire and explosion due to defective battery

The safety electronics on damaged or faulty batteries may fail. The residual voltage can cause a short circuit. Batteries may self-ignite and explode.

- ▶ Batteries with external damage must be removed from service immediately.
- ▶ Never allow damaged batteries to come into contact with water.
- ▶ If a battery is dropped or struck but shows no signs of external damage, remove it from service and observe it for at least 24 hours.
- ▶ Faulty batteries are hazardous goods. Dispose of faulty batteries properly and as quickly as possible.
- ▶ Store in a dry place until disposal. Never store in the vicinity of flammable substances.
- ▶ Never open or repair batteries.

The components of the drive system are checked constantly and automatically. If an error is detected, the respective error code appears on the *display*. The drive may be shut off automatically, depending on the type of error.

### 8.4.17.1

#### First aid

If an error message is displayed, run through the following actions:

- ▶ Make a note of the system message.
- ▶ Shut off and re-start the drive system.
- ▶ If the system message is still displayed, remove and then re-insert the battery.
- ▶ Re-start the drive system.
- ▶ Contact your specialist dealer if the system message is still displayed.

## Maintenance

### 8.4.18 First aid in case of complete failure

Problem	Possible cause	Solution
Display and/or drive system cannot be activated.	Battery malfunction despite full charge.	<ul style="list-style-type: none"> <li>▶ Press the On-Off button (battery).</li> <li>▶ Check whether the battery can be switched on.</li> <li>⇒ The LEDs on the battery charge level indicator should illuminate.</li> <li>⇒ If this is not the case, the battery may be defective. Contact your specialist dealer.</li> </ul>
	Battery is not correctly positioned in the mount.	<ul style="list-style-type: none"> <li>▶ Remove the battery.</li> <li>▶ Replace it again. Make sure it is positioned correctly.</li> </ul>
	Battery is not charged.	<ul style="list-style-type: none"> <li>▶ Fully charge the battery with the charger supplied.</li> </ul>
	Contacts of the battery and/or mount are dirty.	<ul style="list-style-type: none"> <li>▶ Make sure that all contacts are clean.</li> <li>▶ If necessary, clean them with a soft, dry cloth.</li> </ul>
	Display is not correctly positioned in the mount.	<ul style="list-style-type: none"> <li>▶ Remove the display and replace it again. Make sure it is positioned correctly.</li> </ul>
	Contacts of the display unit (1) and/or mount (2) are dirty.	<ul style="list-style-type: none"> <li>▶ Make sure that all contacts are clean.</li> <li>▶ If necessary, clean them with a soft, dry cloth.</li> </ul>
	Plug connections are not properly inserted into the drive unit.	<ul style="list-style-type: none"> <li>▶ Check the cables and plug connections.</li> <li>▶ If necessary, connect them properly.</li> </ul>

## 8.5 Accessories

For bicycles without a kickstand we recommend a parking stand into which either the front or rear wheel can be inserted securely. The following accessories are recommended:

<i>Description</i>	<i>Article number</i>
Protective cover for electrical components	080-41000 ff
Panniers, system component*	080-40946
Rear wheel basket, system component*	051-20603
Bicycle box, system component*	080-40947
Parking stand universal stand	XX-TWO14B
Lighting set, system component**	070-50500 ff

Table 30:

### Accessories

\*System components are matched to the pannier rack and provide sufficient stability due to special transmission of force.

\*\*System components are matched to the drive system.

### 8.5.1 Child seat

#### **Crash caused by incorrect child seat**



Neither the pannier rack nor the bicycle down tube are suitable for child seats and may break. Such an incorrect position may cause a crash with serious injuries for the rider and the child.

- ▶ Never attach a child seat to the saddle, handlebars or down tube.

## Maintenance

---



### Crash caused by improper handling

When using child seats, the riding properties and the stability of the bicycle change considerably. This can cause a loss of control, a crash and injuries.

- ▶ You should practice how to use the child seat safely and reliably before using the bicycle in public spaces.



### Risk of crushing due to exposed springs

The child may crush his/her fingers on exposed springs or open mechanical parts of the saddle or the seat post.

- ▶ Never install saddles with exposed springs if a child seat is being used.
- ▶ Never install seat posts with suspension with open mechanical parts or exposed springs if a child seat is being used.



### NOTICE

- ▶ Observe the legal regulations on the use of child seats.
  - ▶ Observe the operating and safety notes for the child seat system.
  - ▶ Never exceed the total weight of the bicycle.
-



The specialist dealer will advise on choosing a suitable child seat system for the child and the bicycle.

The specialist dealer must mount the child seat the first time to ensure that it is safely fitted.

When installing a child seat, the specialist dealer makes sure that the seat and the fastening mechanism for the seat are suitable for the bicycle and that all components are installed and firmly fastened. They will also ensure that shift cables, brake cables, hydraulic and electrical cables are adjusted as necessary, the rider's freedom of movement is not restricted and the bicycle's permitted total weight is not exceeded.

The specialist dealer will provide instruction on how to handle the bicycle and the child seat.

### 8.5.2

#### Bicycle trailer



##### Crash caused by brake failure

The brake may not work sufficiently if there is an excessive trailer load. The long braking distance can cause a crash or an accident and injuries.

▶ Never exceed the specified trailer load.



▶ The operating and safety notes for the trailer system must be observed.

▶ The statutory regulations on the use of bicycle trailers must be observed.

▶ Only use type-approved coupling systems.

A bicycle which is approved for towing a trailer is equipped with the relevant information sign. Only bicycle trailers with a support load and total mass which do not exceed the permitted values must be used.

## Maintenance

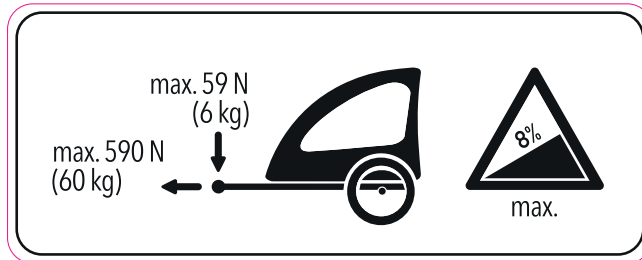

**Figure 74:**

### Trailer sign



The specialist dealer will advise on choosing a suitable trailer system for the bicycle. The specialist dealer must install the trailer the first time to ensure that it is safely fitted.

### 8.5.3



### Pannier rack

The specialist dealer will advise on choosing a suitable pannier rack.

The specialist dealer must mount the pannier rack the first time to ensure that it is safely fitted.

When installing a pannier rack, the specialist dealer makes sure that the fastening mechanism for the rack is suitable for the bicycle and that all components are installed and firmly fastened. They will also ensure that shift cables, brake cables and hydraulic and electrical lines are adjusted as necessary, the rider's freedom of movement is not restricted and the permitted total weight of the bicycle is not exceeded.

The specialist dealer will provide instruction on how to handle the bicycle and the pannier rack.



## 9 Recycling and disposal

**WARNING**

### Risk of fire and explosion

The safety electronics on damaged or faulty batteries may fail. The residual voltage can cause a short circuit. Batteries may self-ignite and explode.

- ▶ Remove batteries with external damage from service immediately and never charge them.
- ▶ If the battery becomes deformed or begins to smoke, keep at a safe distance, disconnect the power supply at the socket, and notify the fire service immediately.
- ▶ Never extinguish damaged batteries with water or allow them to come into contact with water.
- ▶ Faulty batteries are hazardous goods. Dispose of faulty batteries properly and as quickly as possible.
- ▶ Store in a dry place until disposal. Never store in the vicinity of flammable substances.
- ▶ Never open or repair the battery.

**CAUTION**

### Chemical burns to the skin and eyes

Liquids and vapours may leak from damaged or faulty batteries. They can irritate the airways and cause burns.

- ▶ Avoid contact with leaked liquids.
- ▶ Immediately consult a doctor in case of contact with the eyes or any discomfort.
- ▶ In case of contact with the skin, rinse off immediately with water.
- ▶ Ventilate the room well.

## Recycling and disposal

---



This device is marked according to the European Directive 2012/19/EU on waste electrical and electronic equipment – WEEE and accumulators (Directive 2006/66/EC). The directive provides the framework for the EU-wide return and recycling of used devices, which are collected separately and in an environmentally sound manner.



The bicycle, battery, motor, display and charger are recyclable materials. You must dispose of and recycle them separately from domestic waste in compliance with the applicable statutory regulations.

Sorted waste collection and recycling saves on raw material reserves and ensures that all the regulations for health and environmental protection are met when the product and/or the battery are recycled.

- ▶ Never dismantle the bicycle, battery or charger for disposal.
- ▶ The bicycle, display, the unopened and undamaged battery and the charger can be returned to any specialist dealer free of charge. Depending on the region, further disposal options may be available.
- ▶ Store the individual parts of the decommissioned bicycle in a dry place, free from frost, where they are protected from direct sunlight.

## 10 Appendix

### 10.1 System messages

Code	Description	Method of resolution
10	The battery voltage is too low.	► Charge the battery with the charger.
11	The battery voltage is too high.	► Switch off the system completely using the On-Off button on the battery and then switch it on again. ► Contact your specialist dealer if the problem persists.
12	The battery is almost or completely discharged.	► Charge the battery with the charger.
20	Electrical measurements are incorrect.	► Switch off the system completely using the On-Off button on the battery and then switch it on again. ► Contact your specialist dealer if the problem persists.
21	The temperature sensor is faulty.	
23		
24	The internal voltage is outside the working range.	► Charge the battery with the charger.
25	Error in the motor current measurement.	► Switch off the system completely using the On-Off button on the battery and then switch it on again. ► Contact your specialist dealer if the problem persists.
26	A software reset was carried out.	
30	Error in the push assist system.	
40	Overcurrent detected in the motor.	► Reduce the motor load by pedalling less or reducing the level of assistance
41	Overcurrent detected in the motor.	► Reduce the motor load by pedalling less.
42	Fault in the motor rotation.	► Switch off the system completely using the On-Off button on the battery and then switch it on again. ► Contact your specialist dealer if the problem persists.
43	Short circuit in motor.	► Contact your specialist dealer if the problem persists.
44	Motor is overheating.	► Reduce the motor load by pedalling less or reducing the level of assistance.

**Table 31:** List of system messages

## Appendix

Code	Description	Method of resolution
45	The software has corrected an error during motor rotation.	▶ Switch off the system completely using the On-Off button on the battery and then switch it on again.
46	No motor movement detected, although a current >2A was measured.	▶ Contact your specialist dealer if the problem persists.
60	Interruption of data exchange on the CAN-BUS.	▶ Check the cables and connectors of all components of the drive system.
70	Pedal force not in the valid range.	
71	No pedal rotation detected.	▶ Switch off the system completely using the On-Off button on the battery and then switch it on again.
72	No pedal force detected.	▶ Contact your specialist dealer if the problem persists.
73	Fault in connection to pedal force sensor.	
80	Incorrect motor parameter.	▶ Switch off the system completely using the On-Off button on the battery and then switch it on again. ▶ Contact your specialist dealer if the problem persists.
81	Speed not detected.	▶ Make sure that the spoke magnet is correctly positioned opposite the speed sensor.
82	The program was manipulated.	▶ Switch off the system completely using the On-Off button on the battery and then switch it on again.
83	Error in program process.	
84	Incorrect motor parameter.	▶ Contact your specialist dealer if the problem persists.

**Table 31:** List of system messages

## 10.2 EC declaration of conformity

### Translation of the original EC declaration of conformity

The manufacturer:

ZEG Zweirad-Einkaufs-Genossenschaft eG  
 Longericher Straße 2  
 50739 Köln, Germany



hereby declares that the electrically power assisted cycles of types:

19-17-1009, 19-17-1010, 19-17-1011, 19-17-1012, 19-17-1013, 19-17-1014, 19-17-1015, 19-17-1016,  
 19-17-1017, 19-17-1018, 19-17-1019, 19-17-4133, 19-17-4134, 19-17-4135, 19-17-4136, 19-17-4137,  
 19-17-4138, 19-17-4138

year of manufacture 2018 and year of manufacture 2019,  
 comply with all applicable requirements of **Machinery Directive 2006/42/EC**.

The following standards were used: **EN ISO 12100:2010** Safety of machinery - General principles of design - Risk assessment and risk reduction, **EN 15194:2015**, Bicycles - Electric motor assisted wheels - EPAC bicycles, **EN ISO 4210**, Bicycles - Safety requirements for bicycles, **EN 11243:2016**, Bicycles - Luggage racks for bicycles - Requirements and test methods and **EN 82079 1:2012**, Development of instructions for use - Outlines, contents and presentation - Part 1: General principles and detailed requirements.

Ms. Janine Otto (Technical Editor), c/o ZEG Zweirad-Einkaufs-Genossenschaft eG, Longericher Straße 2, 50739 Köln, Germany, is authorised to compile the technical documentation.

Cologne, 22/11/2018

Place, date and signature

Egbert Hageböck

-Chairman-

## Appendix

### 10.3 Parts list

Model	Lacuba Evo 25S
Motor	Brose T
Display	Center display with control panel
Rechargeable battery	EVO 650
Charger	4
Brakes	Shimano BR-MT201
Rear derailleur	Shimano Deore
Gear shift	10
Fork	Suntour NEX-E25 DS HLO CTS
Seat post	Kalloy, SP-368
Tyres and size	Supero Optima Safe, 44-622
Rims	Ryde, Taurus 2000
Mudguard	SKS PET A53 MK
Saddle	Selle Royal, Look-In
Stem	Kalloy, AS-021
Headset	ChinHaur
Handles	Ergon, GP-3L / GC10
Pedals	Wellgo C-211 with sandpaper

**Table 32: Parts list for Lacuba Evo 25S**

<b>Model</b>	<b>Lacuba Evo Cross</b>
Motor	Brose S
Display	Center display with control panel
Rechargeable battery	EVO 650
Charger	4
Brakes	Tektro HD-M275/276
Rear derailleur	Shimano Deore
Gear shift	10
Fork	Suntour SF17-NCX-E LO Air CTS
Seat post	Kalloy, SP-368
Tyres and size	Smart Sam, 47-622 K-Guard
Rims	Ryde, Taurus 2000
Mudguard	SKS Velo 55
Saddle	Selle Royal, Look-In
Stem	Kalloy, AS-007N
Headset	ChinHaur
Handles	VELO, VLG-1551AD3
Pedals	Wellgo C-211 with sandpaper

**Table 33: Parts list for Lacuba Evo Cross**

<b>Model</b>	<b>Lacuba Evo 8</b>
Motor	Brose T
Display	Center display with control panel
Rechargeable battery	EVO 650
Charger	4
Brakes	Shimano BR-MT201
Rear derailleur	Shimano Nexus
Gear shift	8
Fork	Suntour SF17-NCX-E LO Air CTS
Seat post	Kalloy, SP-368
Tyres and size	Big Apple, 50-622 K-Guard
Rims	DDM-2
Mudguard	SKS PET A56
Saddle	Selle Royal, Look-In
Stem	Satori, UP3-AHS
Headset	ChinHaur
Handles	Ergon, GP-3L / GC10
Pedals	Wellgo C-211 with sandpaper

**Table 34: Parts list for Lacuba Evo 8**

## Appendix

Model	Lacuba Evo 25
Motor	Brose S
Display	Center display with control panel
Rechargeable battery	EVO 650
Charger	4
Brakes	Shimano BR-MT400
Rear derailleur	Shimano Deore
Gear shift	10
Fork	Suntour SF17-NCX-E LO Air CTS
Seat post	Kalloy, SP-368
Tyres and size	Big Apple, 50-622 K-Guard
Rims	HC-26S
Mudguard	SKS PET A56
Saddle	Selle Royal, Look-In
Stem	Kalloy, AS-021
Headset	ChinHaur
Handles	Ergon, GP-3L / GC10
Pedals	Wellgo C-211 with sandpaper

**Table 35: Parts list for Lacuba Evo 25**

Model	Lacuba Evo Lite 5
Motor	Brose SL
Display	Center display with control panel
Rechargeable battery	SuperCore
Charger	4
Brakes	Shimano BR-MT400
Rear derailleur	Shimano Inter5
Gear shift	5
Fork	Suntour SF17-NCX-E LO Air CTS
Seat post	Kalloy, SP-368
Tyres and size	Marathon Plus, 47-622
Rims	WTB, XC-21D
Mudguard	SKS PET A53 MK
Saddle	Selle Royal, Look-In
Stem	Kalloy, AS-021
Headset	FSA, Orbit
Handles	Ergon GP-1L
Pedals	Wellgo C-211 with sandpaper

**Table 36: Parts list for Lacuba Evo Lite 5**



<b>Model</b>	<b>Lacuba Evo Lite 11</b>
Motor	Brose SL
Display	Center display with control panel
Rechargeable battery	SuperCore
Charger	4
Brakes	Magura MT4
Rear derailleur	Shimano XT
Gear shift	11
Fork	Suntour SF17-NCX-E LO Air CTS
Seat post	Kalloy, SP-368
Tyres and size	Marathon Plus, 47-622
Rims	WTB, XC-21D
Mudguard	SKS PET A53 MK
Saddle	Selle Royal, Look-In
Stem	Kalloy, AS-021
Headset	FSA, Orbit
Handles	Ergon GP-1L
Pedals	Wellgo C-211 with sandpaper

**Table 37:** **Parts list for Lacuba Evo Lite 11**

## Table of figures

### 10.4

### Table of figures

Figure 1:	Type plate, example, 17
Figure 2:	Bicycle viewed from the right; Lacube EVO Lite 5 used as example, 24
Figure 3:	Detailed view of bicycle from rider position, example, 25
Figure 4:	Components of the wheel – example showing front wheel, 26
Figure 5:	Rim brake components with details; Magura HS22 used as an example, 28
Figure 6:	<i>Rim brake locking lever</i> , closed (1) and open (2), 29
Figure 7:	Bicycle brake system with a disc brake, example, 30
Figure 8:	Brake system with a back-pedal brake, example, 31
Figure 9:	Bicycle without suspension (1) and with suspension (2) when riding over an obstacle, 32
Figure 10:	Example showing Suntour fork: The stem and handlebars are fastened to the fork shaft (1). The wheel is fastened to the quick release axle (6). Other elements: The compression setting (2), crown (3), Q-Loc (5), dust seal (6), fork end for quick release (7), stanchion (8) and spring (9), 33
Figure 11:	Air suspension fork structure, Suntour, 34
Figure 12:	Diagram of drive system, 35
Figure 13:	Diagram of electric drive system, 36
Figure 14:	Evo 650 battery details, 38
Figure 15:	Display details, 40
Figure 16:	On-screen indicators overview, 41
Figure 17:	Operating element overview, 45
Figure 18:	Fastening the transport securing device, 51
Figure 19:	Bicycle brake system with a disc brake, example, 54
Figure 20:	Fully inserting the axle, 60
Figure 21:	Tightening the axle, 60
Figure 22:	Pushing the quick release lever into the axle, 61
Figure 23:	Tightening the securing screw, 61
Figure 24:	Tightening the inserted axle, 62
Figure 25:	Tightening the axle, 62
Figure 26:	Pushing the axle into the hub, 64
Figure 27:	Tightening the axle, 64
Figure 28:	Pushing the quick release lever into the axle, 65
Figure 29:	Securing the lever, 65
Figure 30:	Perfect position for the clamping lever, 66

---

## Table of figures

- Figure 31: Adjusting the quick release clamping force, 66
- Figure 32: Open and closed flange, 68
- Figure 33: Pushing the quick release in, 68
- Figure 34: Adjusting the clamping, 69
- Figure 35: Closing the quick release, 69
- Figure 36: Horizontal saddle tilt, 73
- Figure 37: Optimal saddle height, 74
- Figure 38: Seat post quick release (3) with clamping lever (5) and setting bolt (4) in the open position (1) and in the direction of the closed position (2), 74
- Figure 39: Detailed view of the seat post – examples of the minimum insertion depth marking, 75
- Figure 40: The seat post activation lever can be mounted either on the left (1) or the right (2) side of the handlebars, 76
- Figure 41: Knee cap perpendicular line, 77
- Figure 42: Open (2) and closed (1) clamping lever on the stem; by.schulz speedlifter used as an example, 79
- Figure 43: Pulling locking lever upwards; by.schulz speedlifter used as an example, 80
- Figure 44: Using the twist knob (1) to adjust the pressure point, 82
- Figure 45: Brake lever grip distance, 83
- Figure 46: Using the setting screw (2) to adjust the distance from the brake lever to the handlebar grip (1), 83
- Figure 47: Negative deflection setting wheel on the suspension fork crown, 85
- Figure 48: Screw caps in different designs, 87
- Figure 49: Attaching the display, 102
- Figure 50: Removing the display, 103
- Figure 51: Display with high (2) and low (1) gear recommendation, 107
- Figure 52: Down shifter (1) and up shifter (2) on the left (I) and right (II) shift, 108
- Figure 53: Example; Shimano Nexus gear shift: twist grip (1) for the hub gear with its screen (3), the direction of rotation to switch up a gear (2) and the direction of rotation to switch down a gear (4), 110
- Figure 54: Front (2) and rear (1) brake lever; Shimano brake used as an example, 115
- Figure 55: Suntour compression adjuster with the OPEN (1) and LOCK (2) positions, 116

## Table of figures

---

- Figure 56: FOX compression adjuster with the OPEN (1) and HARD (2) positions, 117
- Figure 57: FOX compression adjuster on the rear frame damper with the OPEN (1), MEDIUM (2) and HARD (3) positions, 118
- Figure 58: Fine adjustment of the OPEN position is made using the adjuster (4), 118
- Figure 59: Checking the chain and belt tension, 133
- Figure 60: Wheel quick release, version I, with clamping lever (2), fork (1) and setting nut (3), 138
- Figure 61: Quick release, version II, with clamping lever (1), axle (2), setting nut (3), and detailed view of the open (4) and closed (5) flange, 139
- Figure 62: Quick release, version III, with axle (1) and clamping lever (2), 140
- Figure 63: Wheel quick release, version IV, with twist knob (1) and clamping lever (2), 141
- Figure 64: Quick release, version V, with axle (1) and clamping lever (2), 142
- Figure 65: Flipping the quick release into the recess (1), 142
- Figure 66: Setting the clamping force in the middle of the clamping lever (1) with a hexagon socket spanner (2), 143
- Figure 67: Dunlop valve with union nut (1) and rim nut (2), 144
- Figure 68: Presta valve with valve insert (1), knurled nut (2) and rim nut (3), 145
- Figure 69: Schrader valve with rim nut (1), 146
- Figure 70: Adjusting sleeve (1) for the single-cable cable-operated gear shift with shifter housing (2), example, 147
- Figure 71: Adjusting sleeves (2) on two alternative versions (A and B) of a dual-cable cable-operated gear shift on the chain stay (1), 148
- Figure 72: Twist grip with adjusting sleeves (1) and play of the gear shift (2), 149
- Figure 73: Brake lever (1) of the hydraulically operated rim brake with setting bolt (2), 150
- Figure 74: Trailer sign, 158

## 10.5 Index

- A**
- Air valve
    - Fork, 34
  - Alternative equipment, 16
  - Alternative version, 16
- B**
- Back-pedal brake, 28, 30, 31
    - braking, 115
  - Battery, 38
    - charging, 98
    - checking, 59
    - disposing of, 160
    - eliminating charging errors, 153
    - waking, 99
  - Belt tension, 132
  - Bike stand, see Kickstand
  - Brake arm, 28
  - Brake calliper, 30, 54
  - Brake disc, 30, 54
  - Brake lever, 25
    - adjusting the pressure point 81
  - Brake lining, 28, 30, 54
    - maintaining, 131
  - Brake,
    - using the transport securing system, 51
  - Back-pedal brake, 28, 30, 31
- Break in operation, 53**
- carrying out, 53
  - preparing, 53
- Button,**
- Driving light, 40
  - Info (control panel), 45
  - Minus, 45
  - Plus, 45
- C**
- Chain drive, 35
  - Chain guard,
    - checking, 91
  - Chain tension, 132
  - Chain wheel, 35
  - Chain, 24, 35
    - maintaining, 132
    - replacing, 151, 152
- Charge status indicator, 38**
- Charger,**
- disposing of, 160
- Clamping force,**
- Checking the quick releases, 64, 139
  - Setting the quick releases, 64, 139
- Clock, 43**
- D**
- Data sheet, 1
  - Direction of travel, 35
  - Display, 40
    - attaching, 102
    - removing, 102
  - Drive system, 36
    - switching off, 101
    - switching on, 100
  - Driving light button, 40
  - Driving light, 39
    - checking function, 91
    - replacing, 151, 152
- E**
- EC declaration of conformity, 163
  - Error message, see System message,
- F**
- Fork lock,
    - Position, 34
  - Fork, 26
    - adjusting tyre pressure, 87
  - Fork end, 26
    - structure, 33
  - Frame number, 1
  - Frame, 24
  - Front wheel brake, 28, 30, 31, 54
    - braking, 115
  - Front wheel, see Wheel
- G**
- Gear shift twist grip, 25
    - checking, 131
- Gear shift,**
- maintaining, 131
  - switching, 107
- H**
- Handlebars, 24, 25
  - Headlight, 24, 36
  - Hub, 26
- I**
- Info button, 45
  - Initial commissioning 57
- J**
- Journey information, 43
    - resetting, 106
    - switching, 105
  - Clock, 43
  - Maximum, 43
- L**
- Level of assistance, 42, 44, 45
    - selecting, 105
  - Lighting, see Driving light
- M**
- Mass, see Weight
  - Minimum insertion depth marking, 75
  - Minus button, 45
  - Model year, 17
  - Model, 1
  - Motor, 36
  - Mudguards, 24
    - checking, 91
- O**
- On-screen indicator, 41, 107, 158
  - Operating status indicator, 38
- P**
- Packaging, 56
  - Pannier rack, 24
    - changing, 94
    - checking, 91
    - using, 93
  - Parts list, 163
  - Pedal, 31, 35
  - Plus button, 45
  - Push assist,
    - using, 104

## Index

---

### Q

Quick release,  
Position, 34

### R

Rear light, 24, 36  
Rear wheel brake, 30, 31, 54  
Rear wheel, see Wheel  
Rebound damper adjuster,  
Position, 34  
Reflector, 24  
Rim brake locking lever 29  
Rim, 26  
- checking, 130  
- replacing, 151, 152  
Roller brake,  
-braking, 115

### S

Saddle, 24  
- changing the saddle tilt,  
72  
- changing the seat length,  
77  
- determining the saddle  
height, 73, 77  
Seat post, 24  
- clamping, 81, 82  
Shifter,  
- checking, 131  
- setting, 134, 146, 147,  
150  
Spoke, 26  
Storage, 51  
Storing, see Storage  
Suspension fork head, 26  
Suspension fork, 27, 32  
System message, 44  
- understanding, 153  
System setting, 43  
changeable, 43, 106

### T

Transportation, 49  
Transporting, see  
Transportation  
Type number, 1, 17  
Tyre pressure, 1  
Tyre size, 1

Tyres, 26

- checking, 130  
- replacing, 151, 152

### U

USB port,  
- using, 105

### V

Valve cap, 34  
Valve, 26  
Dunlop valve, 26  
Presta valve, 26  
Schrader valve, 26

### W

Weight,  
permitted total weight, 17  
Unladen weight, 1  
Wheel circumference, 1  
Wheel,  
- maintaining, 130  
Winter break, see break in  
operation  
Working environment, 55

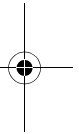
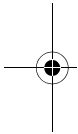

Text and images:  
ZEG Zweirad-Einkaufs-Genossenschaft eG  
Longericher Straße 2  
50739 Köln, Germany

Translation:  
Tanner Translations GmbH+Co  
Markenstraße 7  
40227 Düsseldorf, Germany

Operating instructions: 034-03212\_1.0\_03.12.2018





**[WWW.BULLS.DE](http://WWW.BULLS.DE)**

**ZEG Zweirad-Einkaufs-Genossenschaft eG**  
**Longericher Straße 2**  
**50739 Köln, Germany**  
**Tel.: +49 221 17959 0**

**YOUR BULLS SPECIALIST DEALER**

